



MZAOV CONTROL PANEL INSTALLATION, COMMISSIONING & OPERATING MANUAL

This manual covers the installation, programming and commissioning of the Multizone Automatically Opening Vent Control Panel (MZAOV)

INTRODUCTION

	
Haes Technologies Ltd, Unit 3, Horton Industrial Park, West Drayton, Uxbridge, UB7 8JD 20	
Model Number MZAOV-1001A/1001/1002/1003	CPR Number 1438-CPR-0739
European Standard BS EN 12101-10:2005 Smoke and heat control systems – Part 10: Power supplies	
<p>Haes Technologies Ltd declare that the products identified above conform to the essential requirements specified in the Construction Products Regulation CPR305/2011/EU.</p> <p>In addition, the product complies with the following:</p> <p>2014/35/EU, Low Voltage Directive</p> <p>2014/30/EU, Electromagnetic Compatibility Directive</p> <p>BS EN 61000-6-3:2007 + A1:2011, Electromagnetic Compatibility (EMC) General Standards. Emission standard for residential, commercial & light industrial environments.</p> <p>This product has been designed to comply with the requirement of the low voltage safety and the EMC directives. Failure to follow the instructions may compromise its adherence to this standard.</p>	

Product: Power supply equipment	
Intended use: Smoke and heat control systems	
Essential Characteristics	Requirement clauses in this European Standard
Operational reliability	6 and 7
Performance parameters under fire conditions	4.1
Response time	4.1 and 6.2.2

SAFETY

IMPORTANT NOTICE

PLEASE READ THIS MANUAL CAREFULLY BEFORE HANDLING THE EQUIPMENT AND OBSERVE ALL ADVICE GIVEN WITHIN IT.

THIS PARTICULARLY APPLIES TO THE PRECAUTIONS NECESSARY TO AVOID ELECTRO-STATIC DISCHARGE



Important Safety Notes

The panel is safe to operate provided it has been installed in compliance with the manufacturer's instructions and used in accordance with this manual.

Hazardous voltages are present inside the panel—DO NOT open it unless you are qualified and authorised to do so. There is no need to open the panel's enclosure except to carry out commissioning, maintenance and remedial work. This work must only be carried out by competent service personnel who are fully conversant with the contents of the panel's installation manual and have the necessary skills for maintaining this equipment.

The product must be installed, commissioned and maintained for operation, including periodic checks, in accordance with applicable codes of practice, national standard regulations and local instructions for fire systems appropriate to the country and location of the installation. It is the responsibility of the system user to ensure it is regularly serviced and maintained in good working order.

This equipment is designed to be operated from 230VAC 50/60 Hz mains supplies and is of Class I construction. As such it must be connected to a protective earthing conductor in the fixed wiring of the installation. Failure to ensure that all conductive accessible parts of this equipment are adequately bonded to the protective earth will render the equipment unsafe.

Disclaimer

No responsibility can be accepted by the manufacturer or distributors of this fire alarm panel for any misinterpretation of an instruction or guidance note or for the compliance of the system as a whole. The manufacturer's policy is one of continuous improvement and we reserve the right to make changes to product specifications at our discretion and without prior notice. E & O E.

Warnings



Before installation, refer to the Ratings shown on the label inside the product and to the 'Specifications Chart' in this document. If you are unclear on any point, please DO NOT proceed. Contact the manufacturer or supplier for clarification and guidance.

Only Trained service personnel should undertake the Installation, Programming and Maintenance of this equipment.

Cautions

Equipment Guarantee



This product has been manufactured in conformance with the requirements of all applicable EU Council Directives and is not guaranteed unless the complete system is installed and commissioned in accordance with the laid down national standards by an approved and competent person or organisation.

This product has been designed to comply with the requirements of the Low Voltage Safety and the EMC Directives. Failure to follow the installation instructions may compromise its adherence to these standards.



Waste Electrical and Electronic Equipment Directive

Link to PC configuration software



TABLE OF CONTENTS

INTRODUCTION.....	2
SAFETY	3
IMPORTANT NOTICE	3
Important Safety Notes	3
Disclaimer.....	3
Warnings	3
Cautions	4
TABLE OF CONTENTS	5
PRODUCT OVERVIEW.....	9
General Description of the Equipment	9
Multi-AOV Cabinet.....	11
MZAOV-1001A/-1001/-1002.....	11
MZAOV-1003	11
Circuit Boards.....	12
PSU AOV Card – TPCA027	12
MULTI AOV Card (2-Way) – TPCA028	13
PIR/BMS (Plug-in) Card (2-Way) – TPCA029 (Optional)	14
Circuit Description/Function	15
PSU AOV Card – TPCA027	15
Dual Zone Card (2-Way) – TPCA028	17
PIR/BMS Plug-in Card (2-Way) – TPCA029 (Optional).....	20
Technical Specification	22
General Specification	22
Power Supply Specification – PSM3 - 24 (MZAOV-1001 (3 Amp))	23
Power Supply Specification – PSM5 - 27 (MZAOV-1002 (5 Amp))	24
Power Supply Specification – PSM10-27 (MZAOV-1003 (10 Amp))	25
Electrical Specification - Inputs & Outputs - TPCA027 PSU AOV Card	26
Electrical Specification - Inputs & Outputs - TPCA028 MULTI AOV Card	27
Electrical Specification - Inputs & Outputs - TPCA029 PIR/BMS Plug-in Card.....	27
Detector Circuit Conventional System Schematic.....	28
Detector Circuit Twin Wire System Schematic.....	29
Twin Wire Mode.....	30
INSTALLATION.....	31
Safety	31
ESD Precaution	31
Installing the System.....	32
General	32

Environment	32
Mounting the Cabinet.....	32
Mains Connections	33
Connecting the Batteries	33
Battery Charging Voltage Checks	34
Battery Charging Voltage Calibration.....	34
Sounders/Output Circuits.....	35
Relay Outputs.....	35
OPERATING INSTRUCTIONS.....	37
Panel Control and Indicators.....	37
Control Panel.....	37
Keypads	38
Status LED Indicators.....	39
Software Downloads.....	40
System Requirements	40
User Controls.....	40
General User Controls.....	40
Available Functions	40
Authorized User Controls.....	41
Available Functions	41
Authorised User Menu Options.....	41
Engineer Controls.....	42
Available Functions	42
Engineer Menu Options.....	42
Panel Alarm Conditions	43
Fire Alarm Condition.....	43
Fault Condition	43
Functionality during a system fault.....	43
CONFIGURING THE SYSTEM.....	45
Dependency Modes (False Alarm Management)	45
Type A.....	45
Type B.....	45
Type C.....	46
Accessing the Menu Structure	46
User Menu.....	48
User Menu: DISABLE	49
Disable Menu: REMOVE ALL DISABLEMENT	49
DISABLE Menu: GENERAL	50
DISABLE Menu: CIRCUIT	50

User Menu: TEST.....	51
TEST MODE: ON/OFF.....	51
TEST MODE: SETTINGS.....	52
User Menu: TIME & DATE.....	52
User TIME & DATE Menu: TIME & DATE	52
User TIME & DATE Menu: Set DST	53
User Menu: LAMP TEST	54
User Menu: CONTRAST	55
User Menu: BUZZER.....	55
User Menu.....	56
CONFIG Menu.....	59
CONFIG Menu: PANEL.....	60
CONFIG PANEL Menu: LEARN	60
CONFIG PANEL Menu: OPTIONS	61
CONFIG PANEL Menu: DEFAULT	62
CONFIG PANEL Menu: Password	63
CONFIG Menu: CIRCUIT	63
CONFIG CIRCUIT Menu: CONFIG CIRCUIT	63
CONFIG Menu: DEVICES	64
CONFIG DEVICES Menu: VENT.....	64
CONFIG DEVICES Menu: ZONES.....	66
CONFIG DEVICES Menu: SOUNDERS	67
CONFIG DEVICES Menu: Relay.....	67
CONFIG Menu: PSU	68
CONFIG Menu: P-BUS.....	69
CONFIG Menu.....	70
Report Menu.....	77
Report Menu: EVENTS.....	78
Report EVENTS Menu: ALARM	78
Report EVENTS Menu: FAULT	78
Report EVENTS Menu: DISABLE.....	79
Report EVENTS Menu: TEST	80
Report EVENTS Menu: OTHER	80
Report Menu: STATUS.....	81
Report STATUS Menu: AOV	81
Report STATUS Menu: PSU Card.....	82
Report STATUS Menu: BATTERY	82
Report Menu: HISTORY	83

Report Menu: COUNTER	83
Report Menu: Versions	84
Report Menu.....	86
ENG Menu.....	88
ENG Menu: OUTPUTS.....	88
ENG Menu.....	89
Summary of Menu Structure	90
SERVICE & MAINTENANCE.....	92
SCHEDULE OF TESTING	93

PRODUCT OVERVIEW

Quality, reliability, ease of use and feature rich are attributes that are consistent across the entire range of Haes fire alarm control panels.

The panels are available with three output options, 3 Amp, 5 Amp and 10 Amp for controlling medium to large loads. The 3A (MZAOV-1001A/1001) and 5A panels (MZAOV-1002) can have between 1 and 4 Conventional and/or Twin Wire (sav-wire) detector zones and will control between 1 and 4 vents. The 10A panel (MZAOV-1003) can have between 1 and 8 Conventional and/or Twin Wire (sav-wire) detector zones, controlling between 1 and 8 vents.

For the fire alarm engineer, the panel has been designed to be easy to install and to minimise labour costs, by providing ample room for tasks such as wiring and changing batteries. Activation is via key switch or access code, which means you should always be able to work on the panel and the one man walk tests will help reduce the cost of maintaining the fire alarm system.

The MZAOV panel is designed to be intuitive and flexible for the fire alarm engineer to programme and incorporates a large 240 x 64-pixel graphical display, with an easy-to-navigate menu system, which uses simple discernible icons in each section.

Simplicity is one of the most important aspects when considering the end user of a fire alarm panel. The easy-to-read control panel, with its graphical LCD display and five marked control buttons, and the 3-step silence functionality gives non-technical people the confidence to correctly manage their fire alarm system.

The programming features include 3 different modes to help reduce false alarms. Local fire authorities are demanding this type of functionality to reduce unwanted callouts from alarm receiving centres.

The MZAOV acts as an automatic multi-zone smoke vent opening control panel. The panels are designed to control up to eight 24VDC motorised vents, which use a polarity reversal to control vent direction. The MZAOV panel can be configured to open the vents in a controlled sequence, to aid smoke venting. The actuator output can also be configured for the control of magnetic vents or other purposes.

MZAOV panels support a large range of conventional detectors including, Apollo, Hochiki & Nittan.

This product has been designed and manufactured in the United Kingdom.

General Description of the Equipment

The panels are supplied in two different enclosure sizes. The 3A and 5A versions come in a smaller cabinet, with space for two 12Ah batteries. The 10A version comes in a larger cabinet, with space for two 18Ah batteries. Both modules provide temperature compensated battery management charging.

Additional control input/output cards are available, allowing for the use of PIR sensors, to prevent vents from closing when a trap hazard (i.e. arm or hand) exists, and rain sensors for inclement weather.

The panels have a sheet steel enclosure, suitable for wall mounting, with a hinged and lockable front access door. Cable entry is via 20mm knockouts located at the top and rear of the cabinet.

Different key types are used for the door lock and the 'Activate Controls' key switch.

The panel is fully configurable and uses an easy to navigate menu system, which utilizes a large 240 x 64-pixel graphical display and 5-button Up/Down/Left/Right/Enter (✓) cursor control keys for menu navigation. The panel internal sounders and external alarm sounders are controlled by a 5-button keypad. The controls are accessible by either an Activate Controls key switch, or via a 4-digit code entry, if preferred.

The panels are designed to control up to eight 24VDC motorised vents, which use a polarity reversal to control direction. Each output can be configured to also control magnetic vents.

Multi-AOV Cabinet

MZAOV-1001A/-1001/-1002

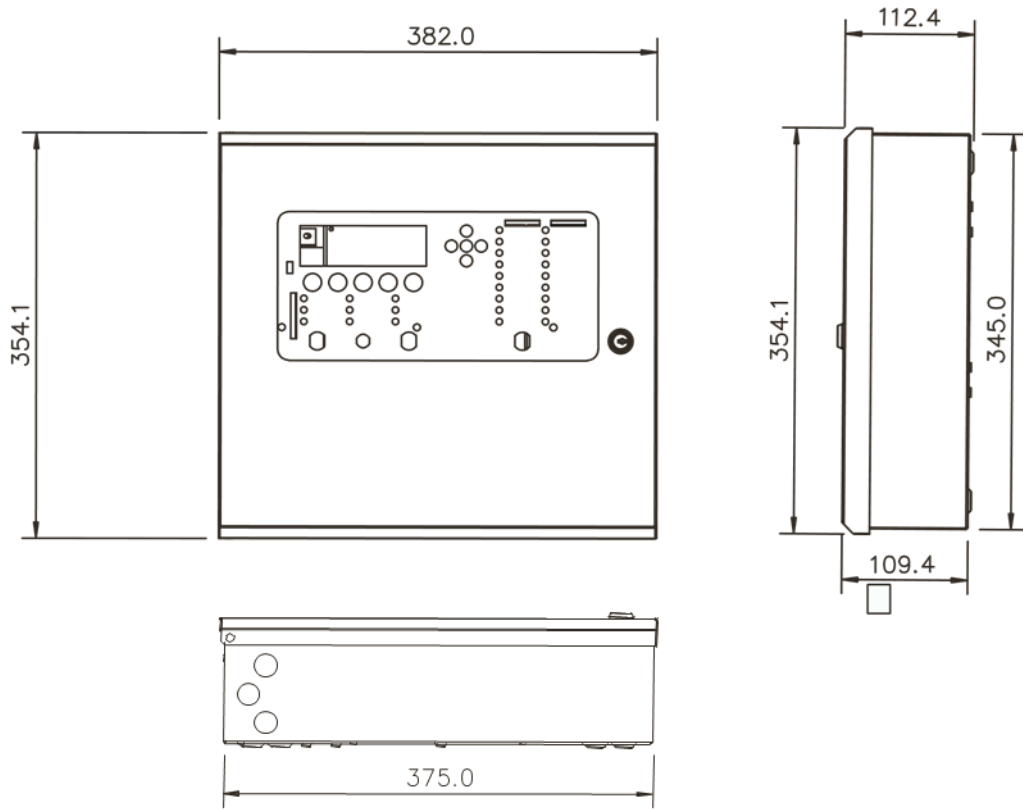

MZAOV-1003

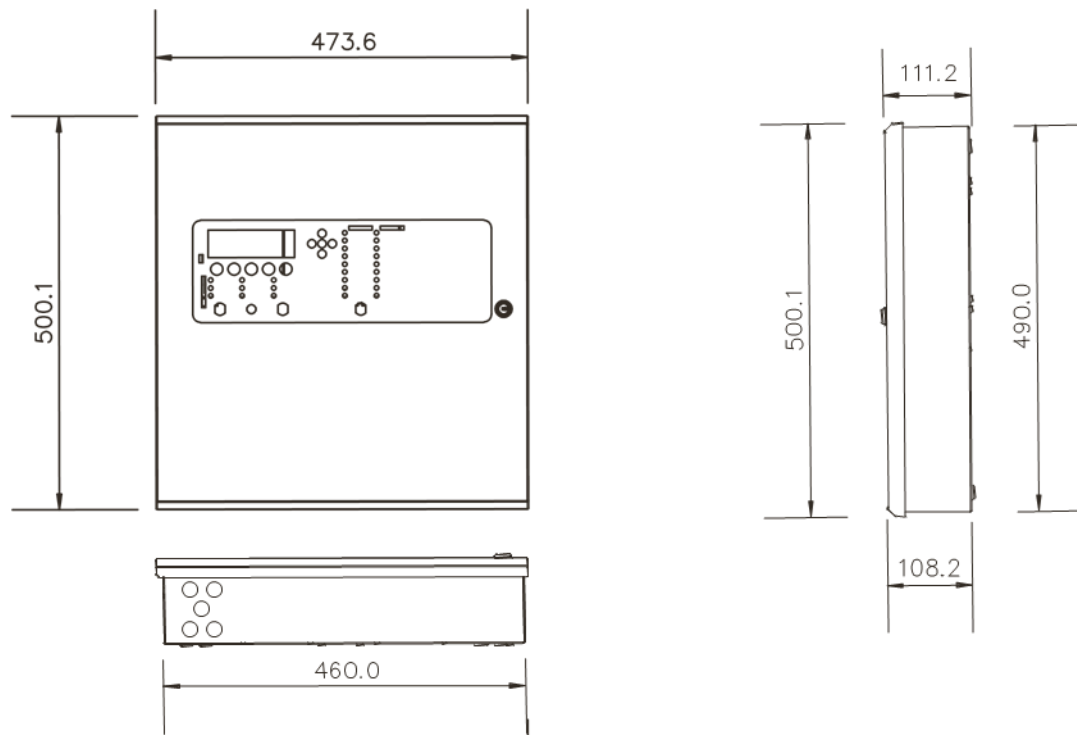

Circuit Boards

PSU AOV Card – TPCA027

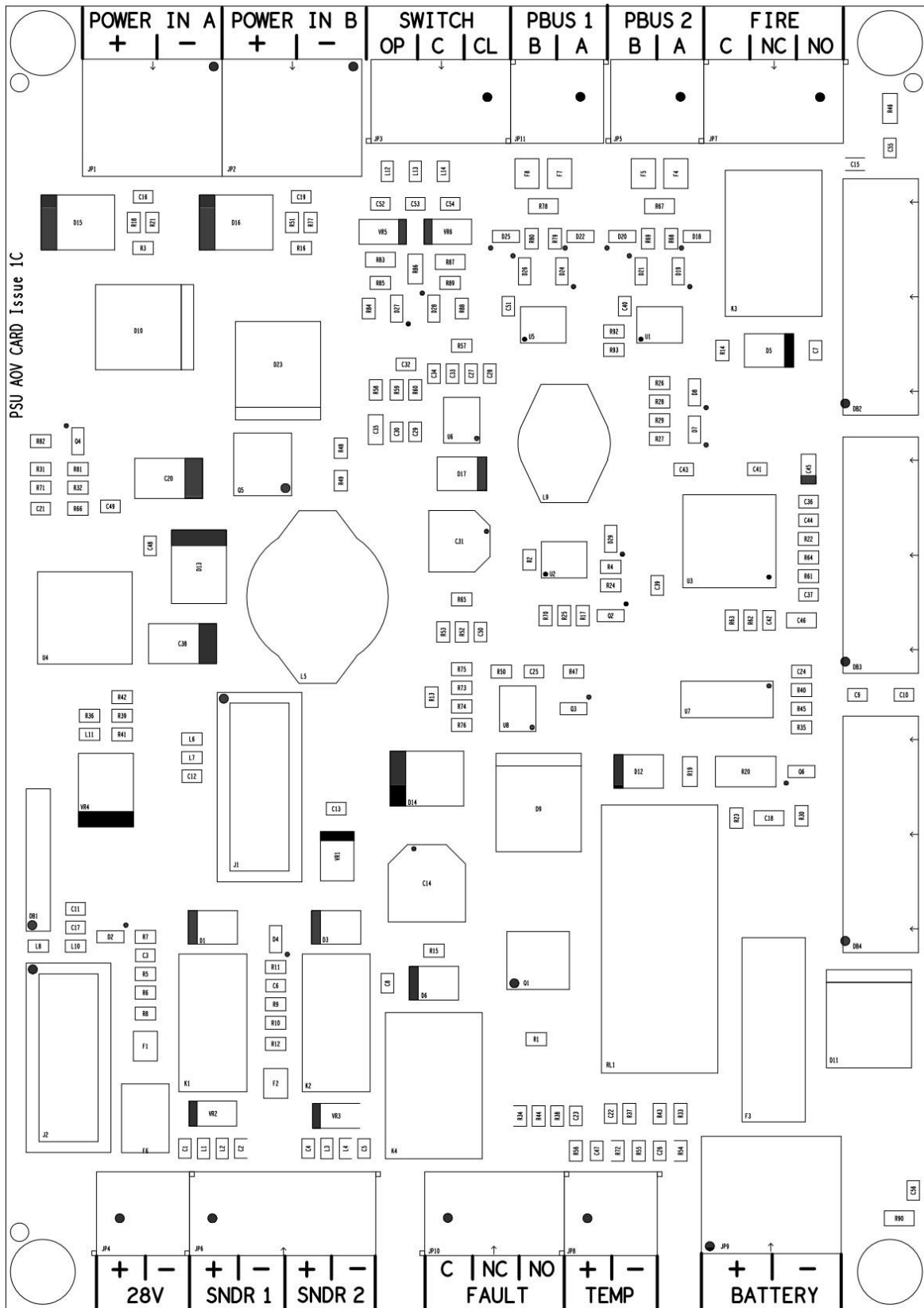

MULTI AOV Card (2-Way) – TPCA028

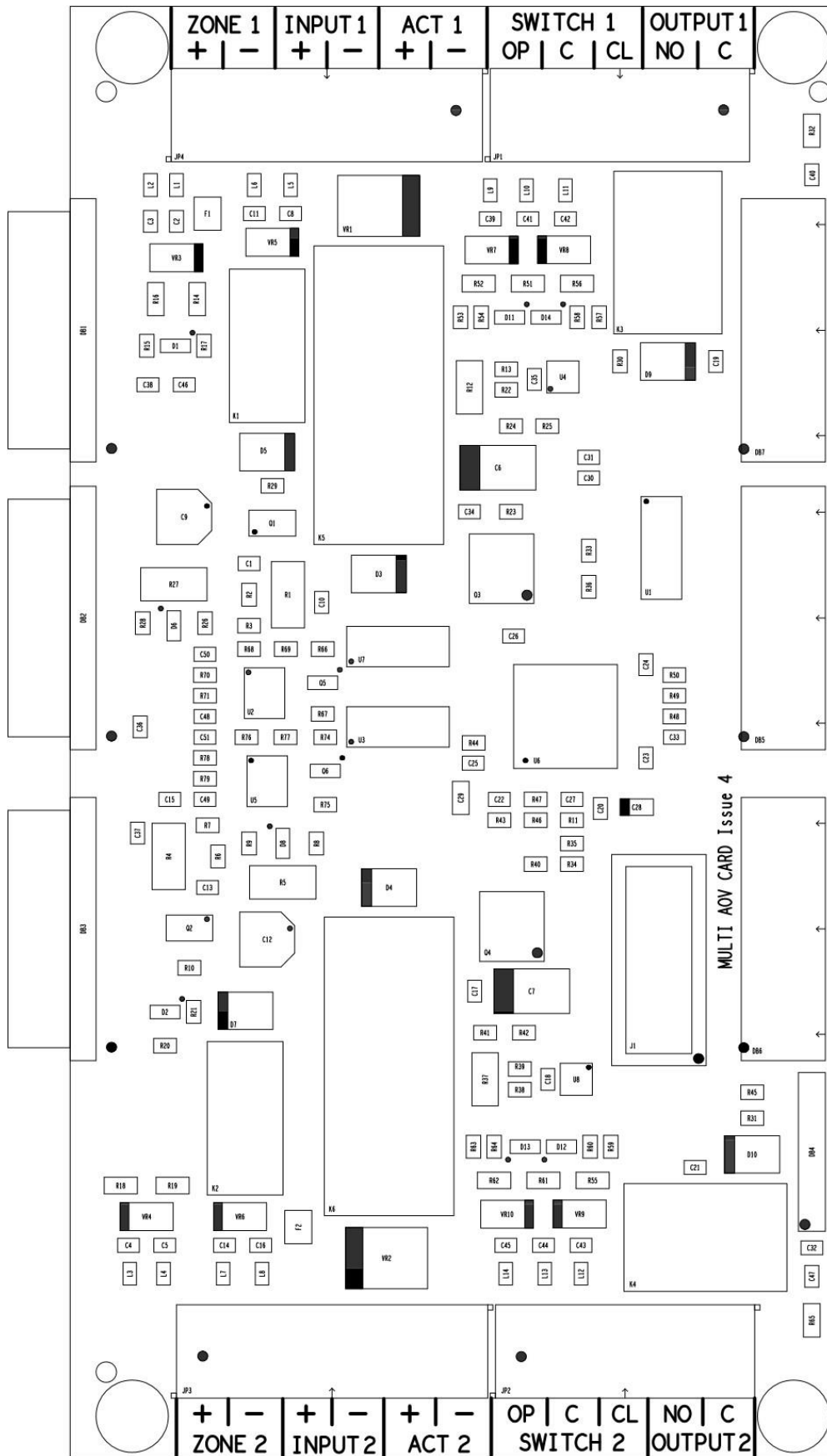

PIR/BMS (Plug-in) Card (2-Way) – TPCA029 (Optional)

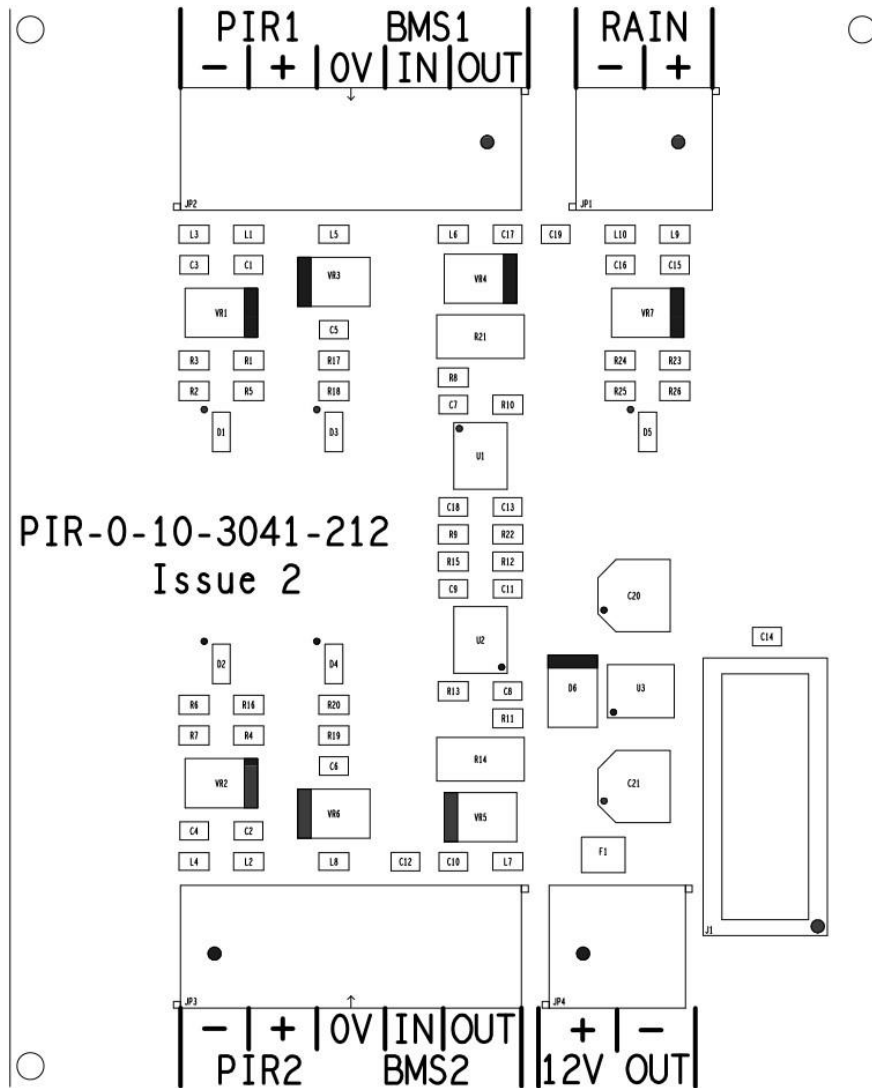

Circuit Description/Function

PSU AOV Card – TPCA027

POWER IN A/POWER IN B (+ -)

Two monitored 28VDC inputs from power supply module. Diode protected for reversal and independent short circuit. Maximum input current, 10 Amps. Input voltage 22 to 32VDC. Configurable for either one, or both, of the inputs to be used.

PBUS 1/PBUS 2 (B A)

Inputs for two RS-485 Peripheral BUS (PBUS) circuits, not currently used. The PBUS circuits are not intended for networking.

FIRE (C NC NO)

Common alarm changeover relay contacts, max 3A at 30VDC (unfused). Activate when an alarm condition exists on any zone circuit or a trigger condition exists on any external Input circuit.

28V + -

28V output, fused at 500mA, for use by external auxiliary equipment (RDUs, PSUs, etc.).

SNDR 1 (+ -)/SNDR 2 (+ -)

Two 24VDC programmable and monitored sounder outputs, configurable as FARE and FWRE (Fire and Fault routing).

They can be programmed to turn OFF or ON in Continuously mode or in Pulsing mode (1s ON and 1s OFF).

The sounders can be configured to be non-silencing or silencing.

FAULT (C NC NO)

Common fault signal changeover relay contacts, max 3A at 30VDC (unfused). Normally energised (failsafe) contacts change-over when any fault is active on the panel or in the event of total power loss.

TEMP (+ -)

Connections for battery temperature sensor.

BATTERY (+ -)

Output connections for 12Ah or 18Ah VRLA batteries charging (temperature compensated). 27.3VDC output at 20C, Max. charging current: 700mA or 1.2A.

SWITCH (OP C CL)

Control input from external 3-way fireman control switch, for manual control of all vents simultaneously:

OP Activates the vent output (fully open vent)

C Common reference

CL Activates the vent output (fully close vent)

In default condition, operation of this switch will fully open/close all vents together, overriding local switch settings/vent positions.

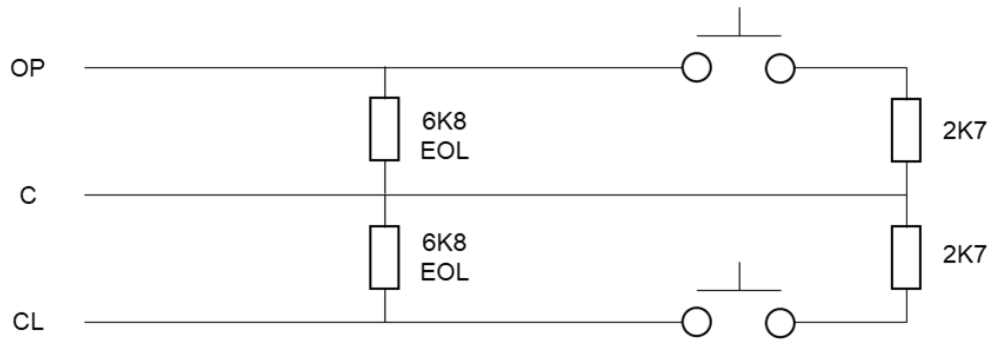

Note: If a local vent control switch is configured as a local fireman switch, controlling one or more local vents, control of those vents by an external 3-way fireman’s switch is overridden.

Note: If neither switch is closed, vents follow panel automatic control (AUTO)

The diagram below shows how to wire a key or rocker switch to the switch inputs.

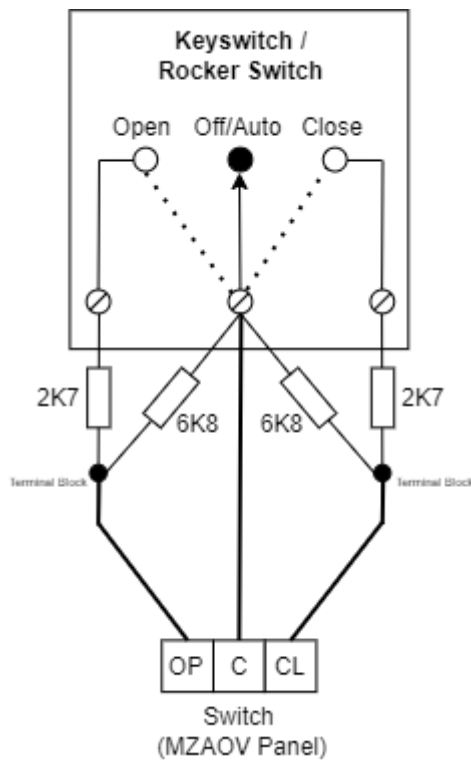

Dual Zone Card (2-Way) – TPCA028

Between one and two (3A/5A box) or one and four (10A box) Dual Zone cards may be fitted, allowing for up to eight vent zones (two per card).

ZONE 1/ZONE 2 (+ -)

Conventional / Twin Wire fire alarm zone circuit. Typical max. load of up to 22 devices, at 18mA each, may be used in each zone circuit, monitored via a 6K8Ω 5% 0.25W end-of-line resistor. Monitoring current limit is 50mA, fused at 500mA.

Detectors in the circuit may use schottky diode bases, for detector removal monitoring; ensuring that if a detector is removed, other devices on the circuit are still functional.

Some programming options are available for these circuits, including the selection of 'Twin Wire' mode. Please refer to the Configuring the System section.

Twin Wire mode allows the use of 24V alarm sounders and beacons on the same circuit as detectors and call points, but in reverse polarity.

Note: In this mode, the detectors require special 'Sav-Wire' bases.

An alarm on the detector circuit will activate the vent outputs, in the same way as activation inputs from the Fireman switch, local vent control switches, or other activation inputs.

INPUT 1/INPUT 2 (+ -)

External activation input (programmable). Alarm activating input; 2K7 alarm, 6K8 Ohm, 5% 0.25W, EOL resistor. Monitoring current limit 14mA, unfused.

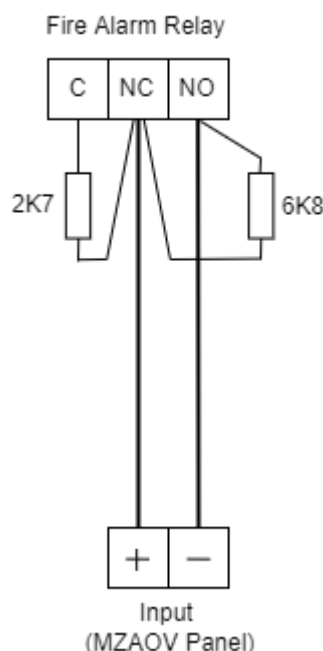

ACT 1/ACT 2 (+ -)

Dual polarity reversal vent drive actuator outputs - 28VDC, max 8A, protected by a current trip circuit. Not normally powered. Operated during an alarm state or by the inputs from the main fireman switch or the local vent control switches, for a configurable time-period of 10 to 300 seconds. The default setting is 60 seconds. During configuration of the panel, this should be set to the time-period required to open/close the vent fully. Polarity is reversed for vent closure. The resistance of the actuator is monitored. When above 10K Ω it is considered an open circuit and less than 10 Ω it is considered a short circuit. This monitoring is only active when the actuator is in the fully open or fully closed position.

From version 1.2 of the display firmware onwards, a configuration option allows the short circuit monitoring to be completely suppressed. This option might not meet the requirements of local regulations. When used in this mode, connecting resistances of less than 1 Ω can cause damage to the circuitry of the actuator driver.

On commissioning, the vent should be set to the fully closed position prior to connection. The actuator outputs may be changed to a continuous, maintained operation during configuration.

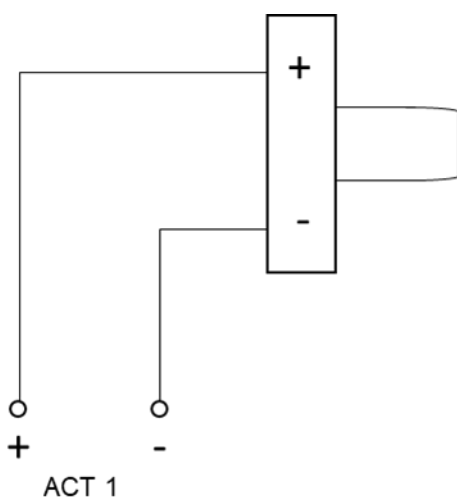

If an actuator output is not being used, a 6K8 resistor should be connected across the terminals. Alternatively, the circuit can be disabled from the config circuits menu.

SWITCH 1/SWITCH 2 (OP C CL)

Local vent control switch inputs, for manual operation of vents by local vent control switch(es).

- OP - Open vents
- C - Common reference for switching inputs
- CL - Close vents

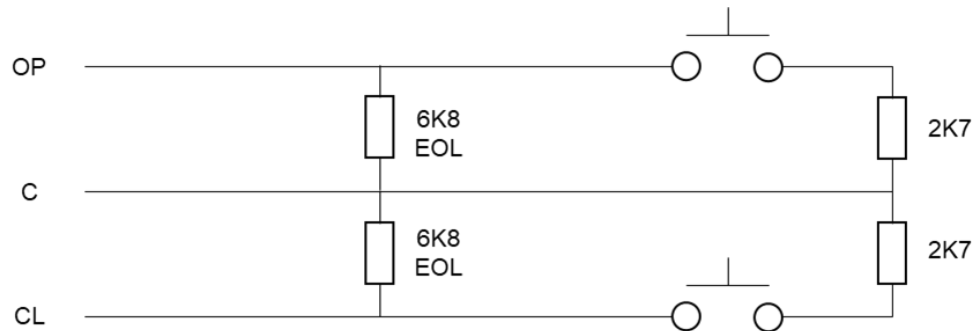

Each local vent control switch operates any number of vents depending on configuration. If the 2K7 resistor is replaced with a 10K resistor, the vent will open or close to a pre-configurable position. This operation can be used as a thermostatic control of the vent.

Local vent control switches can be used as a local Fireman's switch, for their selected vents.

Note: The local vent control switch, when configured as a local fireman's switch, has priority over both the alarm condition vent configuration and the external 3-way Fireman's switch setting.

OUTPUT 1/OUTPUT 2 (NO C)

Reports when local vent zone is in alarm condition.

PIR/BMS Plug-in Card (2-Way) – TPCA029 (Optional)

One PIR card can be fitted to each of the dual zone cards mounted in the panel. This means up to eight PIRs can be fitted in the system.

PIR 1/PIR 2 (+ -)

The PIR input is available to monitor a typical security type PIR with N/C alarm and tamper contacts. The PIR requires a 12VDC supply, taken from the board's 12V output. The input requires a 10K Ω resistance to trigger, with a 6K8 Ω 5% 0.25W EOL resistor. Monitoring current limit is 14mA, unfused.

When operated the PIR alarm prevents the vent from closing to guard against entrapment injury. The PIR should be mounted in accordance with the manufacturer's instructions, to detect any presence in the vicinity of the entrapment risk.

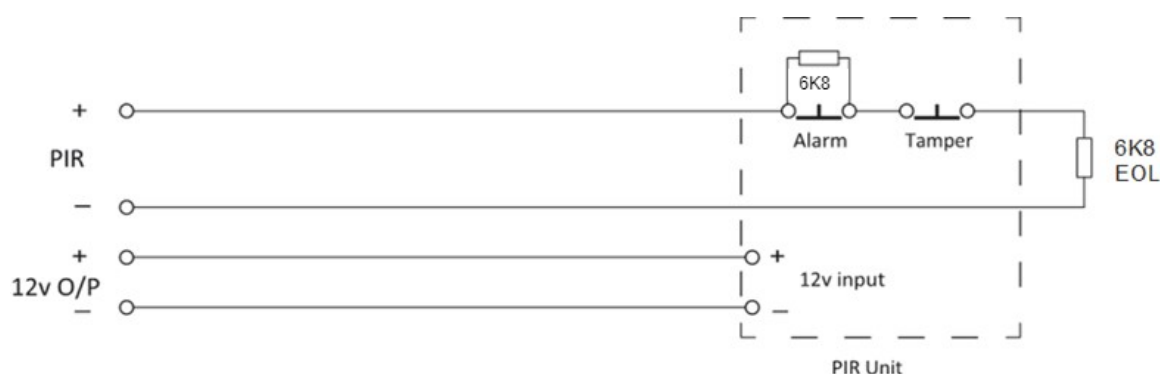

BMS 1/BMS 2 (0V IN OUT)

Building Management System control interface, using 0-10 volt proportional control signals:

- 0V – Common 0V output. This is 0volts common reference for 0-10V input and output.
- IN – Positional voltage input. Accepts 0-10 volt (DC) signal in 1 volt steps per 10% of motor time. Vent position is determined by running time, which by default is 60 seconds, i.e. 10% = 6 seconds running time, 50% = 30 seconds etc. Max input is 10VDC, with 75k Ω impedance.
- OUT – Positional voltage output. This output represents the position of the vent in 10% steps of motor run time. Provides feed-back of the 0-10V input status and vent positional information. Max output is 10VDC 2mA. Max 20K Ω load and 680R impedance.

RAIN (+ -)

Signal input from wind/rain sensors. Typically, a wind/rain sensor will have a closing contact alarm signal and may require a 24V supply. The input requires a 2K7 Ω resistance to trigger, with a 6K8 Ω 5%0.25W EOL resistor. Monitoring current limit is 14mA, unfused. Up to 4 wind/rain sensors can be installed in the system; any one of which can close all manually opened vents but will not override an alarm signal input.

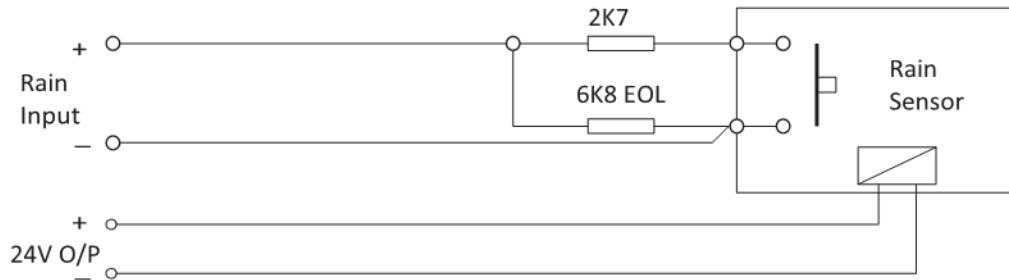
**12V (+ -)**

12VDC supply output for PIR use. Max continuous rated load 100mA, fused at 100mA resettable fuse.

Technical Specification

General Specification	
Enclosure	Steel IP30. Epoxy powder coated Interpon Radon, silver grey
Temperature range:	-5°C to +40°C
Maximum Relative Humidity:	95%
Number of conventional/twin wire detection circuits	1 – 4 (3A/5A) or 1 – 8 (10A)
Conventional/twin wire detector compatibility	Apollo: S65, Orbis. / Hochiki CDX. / Nittan EV
Cabling	Fire resistant screened cable, minimum size 1mm ² . Max cable length 1Km (20 Ohm). Fire Burn, FP200 or equivalent (max capacitance 1uF, max inductance 1 millihenry). Suitable cable glands must be used
Terminal capacity	0.5mm ² to 2.5mm ² solid or stranded wire.

Power Supply Specification – PSM3 - 24 (MZAOV-1001 (3 Amp))		
Mains supply	230VAC +10% / -15%	50Hz max current 1.2 Amp
Mains supply fuse	3.15 Amp (F3.15A 250V)	Not accessible for servicing. Internal to switched mode power unit
Power supply rating	3 Amps total including battery charging	Maximum load shared = 3 Amp
Inrush current	20A	For an interval of 2 seconds
Power supply output voltage	25.7 – 29.7VDC	Set for batt charge O/P 29.0V
Maximum ripple voltage	150mV p-p	
Min current supplied by PSU (I _{min})	40mA	
Maximum continuous load for battery standby (I _{maxA})	I _{maxA} : 120mA (2 zones)	I _{maxB} : 2 Amp
Min/max battery size and type	2 x 12 Ah 12volt VRLA Yuasa NP range	Batteries shall comply to BS 62368-1 requirements. Fire rated batteries shall be used.
Battery charging voltage	27.3VDC nominal	
Battery charging output current	1.2A Current limited	Option to reduce to 700mA
Max current drawn from batteries	3 Amps. Battery fuse 3A HBC 20mm	
Battery high impedance fault (Batt Hi Z)	Resistance > 1 Ohm	1-hour reporting time

Power Supply Specification – PSM5 - 27 (MZAOV-1002 (5 Amp))		
Mains supply	230VAC +10% / -15%	50Hz max current 1.2 Amp
Mains supply fuse	3.15 Amp (F3.15A 250V)	Not accessible for servicing. Internal to switched mode power unit
Power supply rating	5 Amps total including battery charging	Maximum load shared = 5 Amp
Inrush current	20A	For an interval of 2 seconds
Power supply output voltage	25.7 – 29.7VDC	Set for batt charge O/P 29.0V
Maximum ripple voltage	150mV p-p	
Min current supplied by PSU (I _{min})	40mA	
Maximum continuous load for battery standby (I _{maxA})	I _{maxA} : 145mA (4 zones)	I _{maxB} : 4 Amp
Min/max battery size and type	2 x 12 Ah 12volt VRLA Yuasa NP range	Batteries shall comply to BS 62368-1 requirements. Fire rated batteries shall be used.
Battery charging voltage	27.3VDC nominal	
Battery charging output current	1.2A Current limited	Option to reduce to 700mA
Max current drawn from batteries	5 Amps. Battery fuse 5A HBC 20mm	
Battery high impedance fault (Batt Hi Z)	Resistance > 1 Ohm	1-hour reporting time

Power Supply Specification – PSM10-27 (MZAOV-1003 (10 Amp))		
Mains supply	230VAC +10% / -15%	50Hz max current 1.5 Amp
Mains supply fuse	6.3 Amp (F6.3A 250V)	Not accessible for servicing. Internal to switched mode power unit
Power supply rating	10 Amps total including battery charging	Maximum load shared = 10 Amp
Inrush current	20A	For an interval of 2 seconds
Power supply output voltage	26 – 31.5VDC	Set for batt charge O/P 29.0V
Maximum ripple voltage	200mV p-p	
Min current supplied by PSU (I _{min})	40mA	
Maximum continuous load for battery standby (I _{maxA})	I _{maxA} : 195mA (8 zones)	I _{maxB} : 8 Amp
Min/max battery size and type	2 x 18 Ah 12volt VRLA Yuasa NP range	Batteries shall comply to BS 62368-1 requirements. Fire rated batteries shall be used.
Battery charging voltage	27.3VDC nominal	
Battery charging output current	1.2A Current limited	
Max current drawn from batteries	10 Amps. Battery fuse 10A HBC 20mm	
Battery high impedance fault (Batt Hi Z)	Resistance > 1 Ohm	1-hour reporting time

Electrical Specification - Inputs & Outputs - TPCA027 PSU AOV Card		
POWER IN A/POWER IN B - +	28VDC supply input. Diode protected for reversal and independent short circuit	Max input current; 5 amps (5A card) or 10 amps (10A card). Input voltage 22VDC to 32VDC
SWITCH OP C CL	3-way fireman's switch input. 2K7 Ω activation, 6K8 Ω 5% 0.25W EOL resistor between each input and common (C)	Monitoring current limit 3mA for each input, unfused.
FIRE C NC NO (Common Fire relay)	Alarm relay contact. Clean C/O. Max 3A at 30VDC.	Unfused. Activates if panel is in an active alarm condition.
28V +, 0V -	28VDC supply output for fire alarm accessory relays, etc. Max. continuous use 400mA, fused at 500mA	
SNDR 1/SNDR 2 + -	28VDC polarity reversal monitored sounder outputs to fire alarm devices. 6K8 Ω 5% 0.25W EOL resistor	Monitoring current limit 1.5mA, fused at 500mA.
FAULT C NC NO (Common Fault relay)	Maintained fault relay contact. Clean C/O Max 3A at 30VDC.	Unfused
TEMP + -	For temperature compensation control	
BATTERY + -	Battery charging output. 27.3VDC nominal, 1.2A or 700mA current limited	

Electrical Specification - Inputs & Outputs - TPCA028 MULTI AOV Card		
ZONE 1 / ZONE 2 + -	Fire alarm zone circuit. Conventionally wired detection circuit or Twin wire combined detection / sounder circuit, monitored via a 6K8Ω 5% 0.25W end-of-line resistor	Monitoring current limit is 50mA, fused at 500mA. Typical max load 22 devices, at 18mA each, in each zone circuit,
INPUT 1 / INPUT 2 + -	Alarm activating input, 2K7Ω alarm. 6K8Ω 5% 0.25W EOL resistor	Monitoring current limit 1.5mA, unfused.
ACT1 / ACT 2 + -	Dual polarity reversal actuator drive outputs, 28VDC. Max 8 amps. Max. inrush current of 20A for 2 seconds	Monitoring current limit 1.5mA. O/C > 10K, S/C < 10R Trip current set at 20A for 2 seconds then set at 8A.
SWITCH 1 / SWITCH 2 OP C CL	Local vent control switch inputs. 2K7Ω activation, 6K8Ω 5% 0.25W EOL resistor between each input and common (C)	Monitoring current limit 3mA for each input, unfused.
OUTPUT 1 / OUTPUT 2 NO C	Voltage free contacts. Max 3A at 30VDC	Unfused

Electrical Specification - Inputs & Outputs - TPCA029 PIR/BMS Plug-in Card		
PIR 1/PIR 2 + -	The input requires a 10KΩ impedance to trigger, with a 6K8Ω 5% 0.25W EOL resistor	Monitoring current limit 1.5mA, unfused
BMS 1/BMS 2 0 IN OUT	Building Management System positional voltage input, 10% steps of motor time.	Max 10VDC, 75KΩ impedance
Rain +/-	Rain sensor signal input. 2K7Ω alarm. 6K8Ω 5% 0.25W EOL resistor.	Monitoring current limit 1.5mA, unfused
12V +/-	12VDC supply output for PIR power	12VDC, fused at 100mA resettable fuse.

Detector Circuit Conventional System Schematic

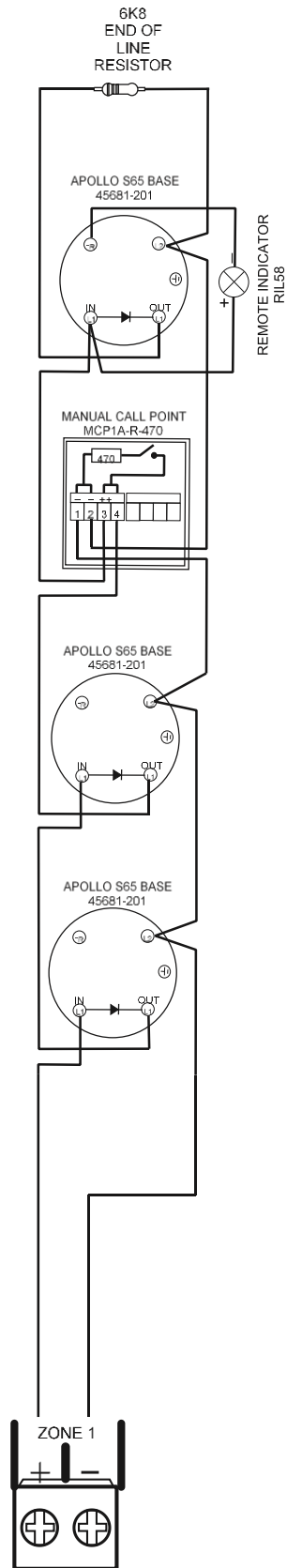

Detector Circuit Twin Wire System Schematic

*Typical Twin Wire
Circuit Wiring*

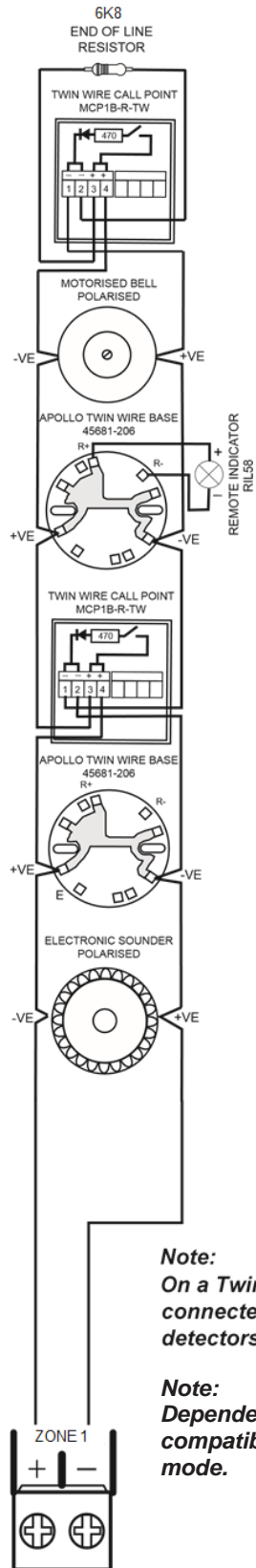

Note:
On a Twin Wire circuit, the sounders are connected in reverse polarity to the detectors and call points

Note:
Dependency modes are not compatible with Twin Wire mode.

Twin Wire Mode

Note: Dependency modes are not compatible with Twin Wire mode.

Twin Wire, often referred to as sav wire, enables sounders and beacons to be connected to the same circuit as the detectors and call points.

In Twin Wire configuration, the detector circuit reverses polarity, in alarm condition, to power the sounders and beacons. The sounders and beacons need to be wired in opposite polarity to the detectors and call points (i.e. detector circuit positive wire connects to detector base and call point positive terminals but sounder and beacon negative terminals).

Note: Twin Wire circuits require special 'sav-wire' detector bases and polarised call points, but standard sounders. Most modern, non-addressable, low current, polarised sounders, bells and beacons are compatible, e.g. Cooper Fulleon, Besson, Klaxon, etc.

To set the ZONE output to Twin Wire mode, select TWIN WIRE during configuration.

INSTALLATION

Safety

This product should be installed, commissioned and maintained by, or under the supervision of, competent persons according to good engineering practice and:

- BS 7671 (IEE wiring regulations for electrical installations)
- Local codes of practice
- Statutory requirements and national standard regulations for fire systems appropriate to the country and location of the installation.
- Any instructions specifically advised by the manufacturer.

You are requested to take such steps as are necessary to ensure that any appropriate information about this product is made available by you to anyone concerned with its use.

Further copies of this User Instruction Manual are available from the website [www.https://haes-tech.com](https://haes-tech.com).

This equipment is designed to be operated from 230V AC 50/60 Hz mains supplies and is of Class I construction. As such it must be connected to a protective earthing conductor in the fixed wiring of the installation. Failure to ensure that all conductive accessible parts of this equipment are adequately bonded to the protective earth will render the equipment unsafe.

	<p>THIS IS A PIECE OF CLASS I EQUIPMENT AND MUST BE EARTHED</p> <p>Only trained, suitably skilled and technically competent service personnel should undertake the Installation, Programming and Maintenance of this equipment.</p>
---	--

ESD Precaution

Observe precautions for handling electrostatic sensitive devices. This particularly applies to the precautions necessary to avoid Electro-Static Discharge.



This equipment is constructed with static sensitive components. Wear an anti-static earth strap connected to panel enclosure's earth point. Before installing or removing any printed circuit boards, or connecting cables, remove all sources of power (mains and battery).

Installing the System

General

Take care to avoid mounting the cabinet near high voltage cables, or areas likely to induce electrical interference. Earth links should be maintained on all system cables and grounded in the control panel. Cabling for the detection and sounder circuits is classed as extra low voltage and must be segregated away from mains voltage.

Any junction boxes used should be clearly labelled FIRE ALARM.

Any ancillary devices, e.g. door retaining magnets, must be powered from a separate power source.

Any coils or solenoids used in the system must be suppressed, to avoid damage to the control equipment.

Environment

The site chosen for the location of the panel should be clean, dry and not subject to shock or vibration. Environments where there is damp, salt air, water ingress or extremes of temperature must be avoided. The temperature should be in the range of -5°C to +40°C, and the relative humidity should not exceed 95%.

Mounting the Cabinet

Before mounting the cabinet, remove the main PCB:

- Remove power supply module wires from the PCB, taking note of where to reconnect them.
- Carefully pull main PCB from its mounting clips.

Secure the cabinet to the wall using the four indented holes in the back of the cabinet. Ensure the cabinet is mounted level and in a convenient location for it to be operated and serviced.

Recommended screws size is M 4.0 * 38mm.

External cables should pass through a suitable gland and fitted to the cabinet via preformed knockouts at the top and rear of the cabinet. Any unused knockouts must be securely blanked off. Remove any knockouts and ensure the cabinet is clear of swarf etc., prior to refitting the PCB.

Knockouts should be removed with a sharp tap at the rim of the knockout using a flat 6mm broad bladed screwdriver. Use of excessive force will damage the enclosure around the knockout.

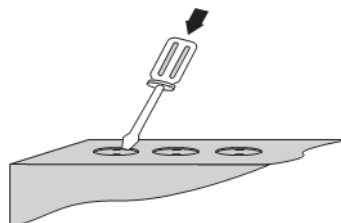

Mains Connections

Note: All connections must be carried out in accordance with local requirements and regulations.

Do not connect the mains supply to the panel until you are fully conversant with the layout and features of the equipment.

A rating plate is attached to the power supply module, describing the nature of the supply permitted.

The incoming mains supply should be brought into the panel via one of the knockouts provided.

A suitable cable gland must be used, to secure the outer sheath of the cable used. The earth must first be connected to the primary earth stud (peg) marked with a \oplus symbol, using a suitable ring crimp.

Sufficient earth lead should be left, to allow Live and Neutral connections to be accidentally pulled from the terminal block while leaving the earth connection intact.

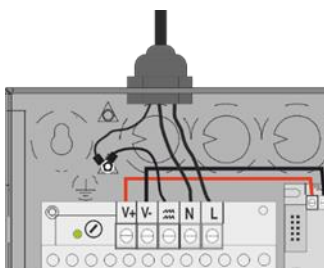

Connecting the Batteries

Batteries of even very small capacity can deliver very high currents, which can cause injuries or fire. Therefore, battery connections should be done with caution.

To optimise the service life of the batteries, the battery charger output voltage varies with temperature.

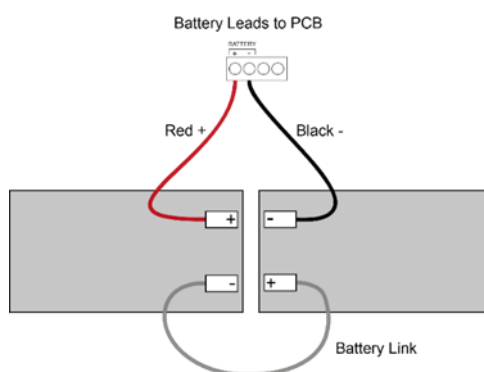

Note: In the event of mains power failure, the battery charger circuit will protect the batteries from full discharge by disconnecting them when they reach below 19v. When the mains supply is restored, the batteries will be automatically reconnected.

Note: If mains power is connected before the batteries, the panel will show a Power Supply fault for up to 1 minute until the monitoring cycle has finished polling. This is normal. If the fault does not clear after 1 minute, check connections.

Battery Charging Voltage Checks

The battery charging voltage is factory calibrated to 27.3VDC +/- 0.2V at 20°C. This should not normally require adjustment. Where battery problems are experienced, the following information should be considered:

- a) If a battery is disconnected from the charger, no voltage will appear on the output leads or terminals, due to intelligent battery controls.
- b) Check the power supply voltage at the PSU 28V and 0V supply output terminals. With the batteries disconnected the voltage should be 29.0VDC +/- 0.2V at between 11°C and 40°C.
- c) To test the batteries, turn off the mains and see if the system will run on the batteries. Check the battery voltage, which should be 26.8V for a good battery or 22V for a flat battery.
- d) When the panel is re-charging a low battery, it should be possible to see the voltage across the batteries increase gradually. If this is not occurring, the batteries or the panel may be faulty.

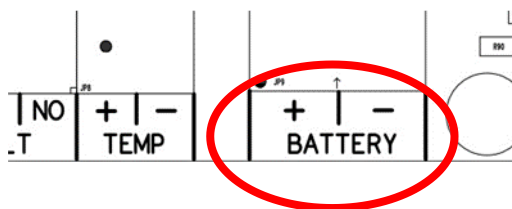

Battery Charging Voltage Calibration

Should the battery charging voltage require calibrating (i.e. following replacement of the main board), proceed as follows:

- Turn Activate Controls key clockwise to On

or

- Use the keypad to enter Authorised User (Access level 2) code 1111:
 - Press ✓ key
 - Use Up/Down arrow keys to increase/decrease the number value
 - Use Left/Right arrow keys to move to the next digit in the 4-digit sequence
 - When all 4 digits have been set to the code 1111, press the ✓ key again
- The Main Menu will become available for operation
- On the Main Menu, use Left/Right arrow keys to move cursor box to Report menu
- Press Enter ✓ key to select the Report menu
- Under Report Menu, use Left/Right arrow keys to highlight the BATTERY option, and then press Enter ✓ key to select it
- BATTERY STATUS menu will display the following:

TEMPERATURE: nn.nn

BATTERY VOLTS: nn.nn



CHARGE: nn.nn



Current: n.nn

DAC OUTPUT: nnn.nn

VREF INT: nnnn

CALIBRATION: n.nnnnnn

- Place Multimeter probes onto battery input terminals and observe the Battery Volts reading
- Using Up/Down arrow keys; adjust the calibration until the BATTERY VOLTS figure, shown on the panel LCD screen, matches the Battery Voltage as measured on the Multimeter
- Press return  key, or Enter  key, to accept the changes and return to the Report Menu. A short acknowledgement sound will be present.

Note: Do not allow the menu to time-out, before pressing the return  key or Enter  key, as the calibration changes made will be lost and the calibration procedure will need to be repeated.

Sounders/Output Circuits

Two (24VDC) programmable and monitored sounder output circuits are provided:

- They can be programmed to turn OFF or ON in Continuously mode or in Pulsing mode (1s ON and 1s OFF).
- The sounders can be configured to be non-silencing or silencing.

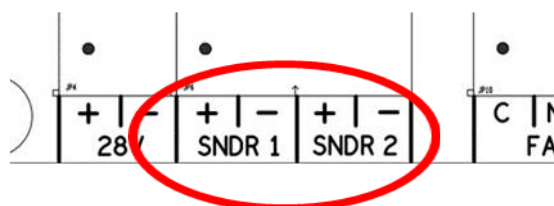

Relay Outputs

The panel is equipped with two relay outputs, which activate on Fault and/or Fire Alarm conditions respectively, by default.

The relays can be programmed to turn OFF or ON in Continuously Mode or in Pulsing Mode (1s ON and 1s OFF) and can be set to operate as General Alarm, Evacuation Alarm, Fails Safe, Fault and Can be Silenced.

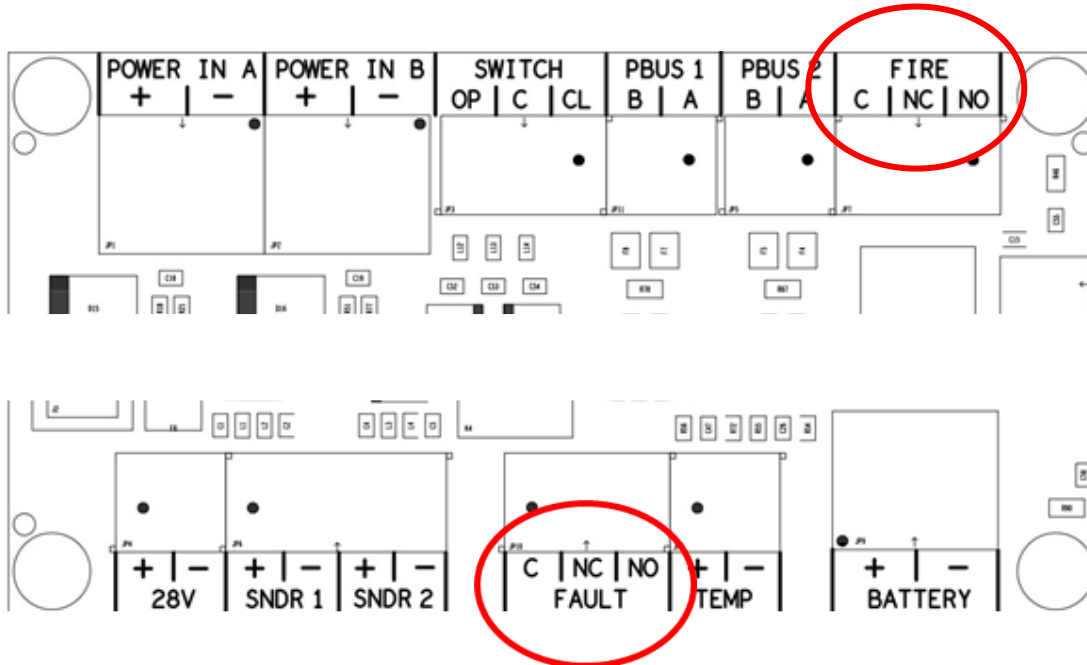

OPERATING INSTRUCTIONS

Panel Control and Indicators





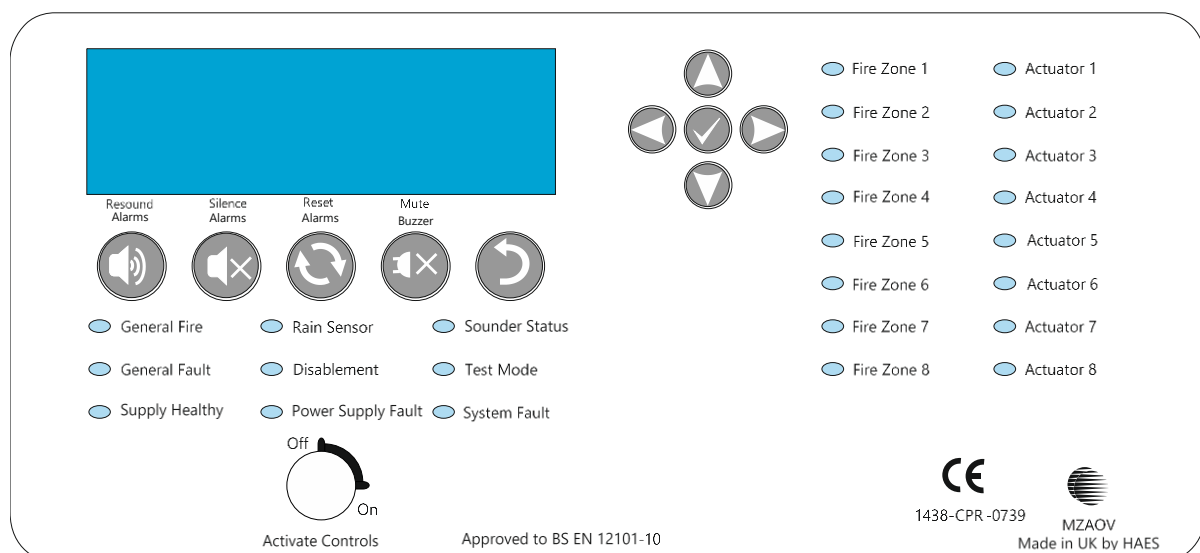

Control Panel

The control panel contains:

- LCD display screen
- 5-button control keypad
- Up/down/left/right arrow keys and enter (✓) key cursor control keypad
- Panel status LED indicators
- Fire Zone 1 - 8 vent control status LED indicators
- Actuator 1 - 8 status LED indicators
- Activate Controls key switch.



Keypads

	Resound Alarms	Use to resound the alarms after they have been silenced. Can also be used to invoke full evacuation.
	Silence Alarms	Use to silence the sounders during an alarm condition.
	Reset System	Resets the panel back to standby mode.
	Mute Buzzer	Mutes the panels internal fire and fault buzzer. (The buzzer will still blip every 5-6 seconds during a fire or fault condition). This function is operational without the need to activate controls.
	Return	Press to exit current menu or command, as indicated in the bottom corner of the LCD display.
	Scroll Display (arrows)	Press to navigate the display messages and menus
	Enter (Tick)	Press to select the available menus Press to confirm selection of a menu option Press to confirm some of the configuration options

Status LED Indicators

LED Name	LED - on steady	LED - pulsing
General Alarm	Indicates panel is in alarm condition that has been silenced.	Indicates panel is in the unsilenced alarm condition.
Rain Status	Indicates rain/wind sensor has been disabled.	Indicates a fault in the Rain/Wind sensor circuit.
Sounder Status	Indicates sounder circuits have been disabled or are in test mode.	Indicates a fault on one or more sounder circuits.
General Fault	Indicates one or more faults are present and the buzzer has been muted	Indicates one or more faults are present.
Disablement	Indicates one or more circuits have been disabled.	N/A
Test Mode	Indicates one or more circuits are in test Mode.	N/A
Supply Healthy	Indicates mains and/or battery supply is present.	N/A
Power Supply Fault	Indicates a power supply fault on mains power input or battery and buzzer has been muted.	Indicates a power supply fault on mains power input or battery
System Fault	Indicates a system failure, panel not functional or the internal PCB configuration has not been set up correctly.	Indicates the panel has recovered from a system fault.
Fire Zone 1 - 8	Indicates vent in the correct position for the active alarm	Indicates vent not in the correct position for the active alarm
Actuator 1 - 8	Indicates vent fault in any of the circuits on either the top or the bottom of the zone card, which are grouped together as two distinct areas.	Indicates vent in-motion

Software Downloads

The Haes MZAOV Configuration panel software enhances the ease of programming of the panel, by enabling the engineer to both download existing panel configurations for amendment, or programme new panel configuration 'off panel' before uploading onto the panel. Programming of the configuration uses easy to follow tables.

The Haes Configuration panel software is available to be downloaded from the Haes website:
www.https://haes-tech.com

System Requirements

The Haes Configuration Panel software is designed for use with Windows 7 and Windows 10 Operating System. It is not intended for use with Apple macOS, Android or Linux OS.

The following are required:

- Laptop or Tablet device running Windows 7 or Windows 10 OS
- Cable with a USB-B connector.

User Controls

Four levels of control, with programmable code entry, are available on the panel:

- General User (Access level 1)
- Authorised User (Access level 2)
- Engineer (Access level 3) (CONFIG Mode)
- Engineer (Access Level 4).

In General User (Access level 1) mode; most of the keypad controls are inactive, to protect the system from unauthorised operation.

The use of a code entry to activate the controls is enabled by default but can be disabled in the Level 3 engineering functions.

Once the panel is powered up, the panel will perform a routine LOOP STATUS check. When this is complete, the LCD screen will display any faults found, accompanied by the relevant status LEDs flashing and a warning tone. After clearing any faults found and a successful LOOP STATUS check, the Title screen will be displayed. The General User (Access level 1) controls are then available.

General User Controls

The General User (Access Level 1) controls are accessible when the Activate Controls key is set to Off and the four-digit access code has not been entered.

Available Functions

The functions that can be performed in Access Level 1 are:

- Mute the internal buzzer 
- View active faults
- Change from General User (Access level 1) to Authorised User (Access level 2); using either the Activate Controls key switch or by entering the four-digit code to access level 2.

Authorized User Controls

The Authorized User (Access level 2) controls can be accessed by:

- Turning the Activate Controls key clockwise into the On position. The padlock symbol will show unlocked and all the buttons on the keypad will be operational. To deactivate the controls, turn the key back to the Off position. The padlock symbol will show locked.

or

- Entering four-digit code 1111:
 - Press ✓ key
 - Use the Up/Down arrow keys to increase/decrease the number value
 - Use the Left/Right arrow keys to move to the next digit in the 4-digit sequence
 - When all 4 digits have been set to the code 1111, press enter ✓ key once again
 - The Main Menu will become available for operation.

Once the four-digit code is entered, or the Activate Controls key is used, the LCD unit will display the Main Menu. Use the Scroll Control keypad up/down and left/right arrows, and the enter ✓ key to navigate the Access level 2 menu.

Note: If the Activate Controls key is in the On position, the keypad will remain active.





Note: It is not possible to remove the key, whilst it is in the On position.

Note: The padlock symbol is shown on the LCD screen, to the right of the Time and Date indication.

Note: The Access level 2 code 1111 is the factory default. The access code may be changed from the CONFIG menu PANEL sub-menu.

Available Functions

The functions that can be performed at Access level 2 are:

- Resound Alarms 
- Silence Alarms 
- Reset the system 
- Mute the internal buzzer 
- Access the Authorised user (Access level 2) menu options, from the Main Menu
- Access the CONFIG menu (Access level 3) controls, for configuration and commissioning of the system, by entering the four-digit access code 3333.

Authorised User Menu Options

The Authorised user (Access level 2) menu options are available from the Main Menu:

- User
- CONFIG
- Report

- ENG

Engineer Controls

The Engineer (Access level 3) controls can be accessed by:

- From the Authorised User (Access level 2) MAIN MENU, use Left/Right arrow keys to move cursor to CONFIG menu icon
- Press ✓ key to select CONFIG menu. The digital display will show the following message:

Enter Level 3 Access Code

- Use the keypad to enter code 3333:
 - Press ✓ key
 - Use the Up/Down arrow keys to increase/decrease the number value
 - Use the Left/Right arrow keys to move to the next digit in the 4-digit sequence
 - When all 4 digits have been set to the code 3333 press ✓ key once again. The Access level 3 menu will become available for operation.

Use the Scroll Control keypad up/down and left/right arrows, and the enter ✓ key to navigate the Access level 3 menu.

Note: The Access level 3 code 3333 is the factory default.

Available Functions

The functions that can be performed at Access level 3 are:

- Set the panel to automatically learn what internal cards are fitted within the panel, and what remote units (connected via the RS-485 Peripheral BUS) and devices (detectors, sounders, call-points, etc.) are connected to the internal cards.
- Configure the outputs for the various external devices (detectors, sounders, etc.).
- Reset panel to factory defaults
- Reset four-digit passcodes

Engineer Menu Options

The Engineer (Access level 3) menu options, available from the MAIN MENU, are:

- CONFIG

Panel Alarm Conditions

Fire Alarm Condition

The display shows location/origin of the fire alarm and the total number of vent zones in a fire alarm condition.

If two or more vent zones enter the fire alarm condition, the display also shows the location of the last zone to enter a fire alarm condition.

In addition:

- The General Alarm LED and the respective Vent active LED(s) will be lit
- The fire alarm bells/sounders will activate (depending on how they are programmed to respond).

To silence the internal buzzer, press the Mute Buzzer button.

To silence the bells, press the Silence Alarm button.

To reset the panel, press the Reset System button.

Fault Condition

If the panel detects a fault condition, the display will indicate the number and nature of the fault(s). The internal buzzer will sound with an intermittent tone and the amber General Fault LED will illuminate pulsing, and any other specific panel or vent zone fault LED(s) will be illuminated.

Press the Left/Right and Up/Down arrow keys to scroll through the list of faults.

Press the Mute Buzzer  key to silence the internal buzzer. The General Fault amber LED will change to steady illumination

Note: The fault condition is non-latching (except System Fault) and the indications will automatically be cleared when the fault is remedied. Press the Reset System  key to clear a fault.

Note: If silenced, the buzzer will re-sound when a new fault occurs.

Functionality during a system fault

A system fault is indicated when a processor controlling a function in the panel has a watchdog time-out or processor failure. In the event of a system fault, the affected board may not be functional. The following indications may be observed:

- Display Board (Main control board)
 - System Fault LED continuous only
 - Continuous buzzer sound
 - Display board is halted and no other indication or control is possible
 - Fault relay is activated.

- Power Supply Board
 - System Fault LED pulsing
 - General Fault LED pulsing
 - Power Supply Fault LED pulsing
 - Fault relay activated
 - Mains or battery power will still operate the panel. Batteries will not be charging
 - Indications will remain until the fault is rectified and the panel is reset
 - Remote status units will cease to function.
- System Fault recovery
 - System Fault LED pulsing
 - General Fault LED pulsing
 - Pulsed buzzer (fault tone) indicates a system fault has occurred, and the affected board has recovered
 - The indication will remain until the panel is reset.

CONFIGURING THE SYSTEM

When the system is installed and is ready to be commissioned, configure as follows:

- Use the CONFIG PANEL menu LEARN option, to enable the panel to automatically learn what internal cards, external devices (detectors, sounders, etc.), and Peripheral BUS (P-BUS) Remote Control Call Points are connected in the system.
- Set the panel user interface controls (Time & Date, Display contrast, internal buzzer volume, etc.), using the User menus described below.
- Configure the system (vent zones, devices, etc.), identified by the CONFIG PANEL menu LEARN option, using the User menu DISABLE sub-menus and CONFIG menus, described below.
- Any alarm or fault events, system status etc., can be viewed using the Report menus, described below.
- Outputs from the various vents and RSUs fitted in the system can be tested from the ENG menu OUTPUTS option, described below.

Dependency Modes (False Alarm Management)

Note: Dependency modes are not compatible with Twin Wire mode.

Dependency modes are features for the processing of confirmation alarms. It is a requirement by some monitoring stations and local fire authorities, to reduce the possibility of false alarms.

The panel has 3 dependency mode options, A, B & C. Only one type can be applied to the panel but any or all zones can be independently set for dependency mode.

Dependency mode, if assigned to a zone, is set to type A by default.

Type A

Dependency 'A' will apply the following sequence:

The first detector alarm is inhibited.

The panel resets and re-checks the inhibited zone within 15-30 seconds (programmable, see CONFIG PANEL: OPTIONS, 5: CONFIRM TIME).

If an alarm is detected, then the panel activates a full fire condition.

If no alarm is detected, the panel stays in an alert condition for 30 minutes. Any new alarm from the same zone within this time activates a full fire condition.

After 30 minutes or if RESET, the panel reverts to step 1.

Type B

Dependency 'B' will apply the following sequence:

The first detector alarm will indicate at the control panel but not activate the sounders.

The panel resets and re-checks the inhibited zone within 1 - 4 minutes (programmable, see CONFIG PANEL: OPTIONS, 5: CONFIRM TIME)

If an alarm is detected, then the panel activates a full fire condition.

If no alarm is detected, the panel stays in an alert condition for 5 - 30 minutes (programmable, see CONFIG PANEL: OPTIONS, 6: INHIBIT TIME). Any new alarm from the same or a different zone within this time activates a full fire condition.

After the time set above or if RESET, the panel reverts to step 1.

Type C

Dependency 'C' will apply the following sequence:

The first detector will indicate at the control panel but not activate the sounders.

The panel will not activate a full fire condition unless a second detector is activated in the same or any other zone.

Accessing the Menu Structure

Power on the panel and wait for it to perform a routine status check. Any faults detected will be displayed, accompanied by a warning tone. Press the Mute Buzzer button to silence the warning tone. Resolve any faults before proceeding.

Next proceed by pressing the ✓ button, the LCD unit displays the following Access Level 2 Menu (see picture below):

Note: Access level 2 Menu will deactivate after 30 sec if not used.



On the LCD screen, the box surrounding the menu icon is the cursor; this can be navigated through the menu options by using the Left/Right arrow keys to select required menu option and then pressing the ✓ key.

The Left/Right and Up/Down arrow keys can then be used to access further sub-menus and options within the main menus.

Press ✓ key to select required sub-menu or option and to make changes to a selected option.

Where there are options that have adjustable values, these are altered with the Up/Down arrow keys followed by pressing ✓ key, when required value is reached.

Use the return ↵ key to exit all menus and options.

To access the menu structure:

- Turn Activate Controls key switch clockwise to On

or

- use the keypad to enter Authorised User (Access level 2) code 1111:
- Press ✓ key to select Access level 2. The digital display will show the following message:

Enter Level 2 Access Code

- Use Up/Down arrow keys to increase/decrease the number value
- Use Left/Right arrow keys to move to the next digit in the 4-digit sequence
- When all 4 digits have been set to the code 1111, press the ✓ key again
- The LCD unit displays the Access Level 2 Main Menu (see picture below), which is available for operation

Note: Access level 2 Menu will deactivate after 30 sec if not used.

User Menu

Accessible from the Main Menu (Access level 2); the User Menu, and its subsequent sub-menus, are used to set-up the panel ready for configuration. The sub-menus available are:

- DISABLE
 - DISABLE Menu
 - REMOVE ALL Disablement
 - GENERAL
 - CIRCUIT
- TEST
 - TEST MODE
 - TEST ON/OFF
 - TEST SETTINGS
- TIME & DATE
 - Time & Date
 - Set DST
- LAMP TEST
- CONTRAST
- BUZZER

To access the MAIN MENU:

- Turn Activate Controls Key to On
- or
- Use the keypad to enter code 1111:
 - Press ✓ key
 - Use the Up/Down arrow keys to increase/decrease the number value
 - Use the Left/Right arrow keys to move to the next digit in the 4-digit sequence
 - When all 4 digits have been set to the code 1111 press ✓ key once again
 - The MAIN MENU will become available for operation.

Note: Access level 2 Menu will deactivate after 30 sec if not used.

User Menu: DISABLE

To enable/disable inputs, outputs, devices, zones and circuits, access the DISABLE sub-menu and its sub-menus:

- On the Main Menu, use Left/Right arrow keys to move cursor box to User menu icon
- Press ✓ key to select the USER menu
- Under USER MENU, use Left/Right arrow keys to move cursor to DISABLE menu icon. Press ✓ key to select the DISABLE sub-menu.
- The following menu will be displayed:
DISABLE MENU
1: REMOVE ALL DISABLEMENTS
2: GENERAL
3: CIRCUIT
- Use the Up/Down arrow keys to move to the required option and press the enter ✓ key to select it.
- Press the return ↵ key to return to the USER MENU.

Disable Menu: REMOVE ALL DISABLEMENT

To remove all disablements currently set in the system:

- From the DISABLE sub-menu, use the Up/Down arrow keys to highlight option 1: REMOVE ALL DISABLEMENT
- Press ✓ key once, a confirmation dialog, with options for NO/YES, will appear:
ARE YOU SURE?
REMOVE ALL DISABLEMENTS
NO YES
- Use Left/Right arrow keys to highlight the YES option and press ✓ key once. A short acknowledgement sound will be present
- When finished, press return ↵ key to return to DISABLE menu.
- Next, press return ↵ key to return to the User menu.

DISABLE Menu: GENERAL

To enable or disable panel sounders, relays, outputs and switch inputs on the PSU card:

- From the DISABLE sub-menu, use the Up/Down arrow keys to highlight the GENERAL option icon, and then press ✓ key to access it.
- The following sub-menu and options will be displayed:

DISABLE Menu

1: SOUNDERS: ENABLED/DISABLED

2: FIRE Relay: ENABLED/DISABLED

3: FARE OUTPUT: ENABLED/DISABLED

4: FAULT Relay: ENABLED/DISABLED

5: FWRE OUTPUT: ENABLED/DISABLED

6: FIREMAN INPUT: ENABLED/DISABLED

- Use the Up/Down arrow keys to move between the options 1 to 6.
- For each of these options, press enter ✓ key to toggle between ENABLED or DISABLED as required.

Note: If any of these options are set to DISABLED, the amber Disablement LED will be illuminated as steady. If the SOUNDERS option is set to DISABLED, the amber Sounder Status LED will also be illuminated.

- When finished, press return ↵ key to accept the changes and return to DISABLE menu. A short acknowledgement sound will be present.
- Press the return ↵ key to return to User menu.

DISABLE Menu: CIRCUIT

To enable or disable elements (zone, inputs, vents) of each detection circuit (depending on the AOV cards fitted):

- From the DISABLE sub-menu, use the Up/Down arrow keys to highlight the CIRCUIT option icon, and then press ✓ key to access it.
- The following sub-menu and options will be displayed:

DISABLE Menu <CIRCUIT 01 – 08>



1: ZONE: ENABLED/DISABLED

2: INPUT: ENABLED/DISABLED

3: ACTUATOR: ENABLED/DISABLED



- Use the Left/Right arrow keys to toggle between circuits 01 to 08 (depending on the AOV cards fitted to panel).
- Use the Up/Down arrow keys to move between the options 1 to 3, for each circuit.
- For each of these options, press enter ✓ key to toggle between ENABLED or DISABLED as required.

Note – If any of these options are set to DISABLED, the amber Disablement LED will be illuminated as steady. If the SOUNDERS option is set to DISABLED, the amber Sounder Status LED will also be illuminated.

- When finished, press return  key to accept the changes and return to DISABLE menu. A short acknowledgement sound will be present.
- Press the return  key to return to User menu.

User Menu: TEST

In TEST MODE, the devices in the Zone(s) in test (i.e. detectors, call points, etc.) can be activated and the panel will automatically reset, enabling the panel to be tested by one person. The Zone(s) to be tested can be set under TEST MODE: SETTINGS, and the TEST MODE can be activated from TEST MODE: ON/OFF:

- On the Main Menu, use Left/Right arrow keys to move cursor box to User menu
- Press  key to select the User menu.
- Under User menu highlight the TEST option and press  key to select it.
- The following sub-menu will be displayed:

```
TEST MODE
ON/OFF      SETTINGS
```

TEST MODE: ON/OFF



This is the main activation control for TEST MODE along with sounder options, any Zones that have been set for TEST MODE will be disabled (i.e. operate normally) unless INCLUDE ALL ZONES or EXCLUDE ALL ZONES function has been set in TEST MODE: SETTINGS.

To set the system TEST MODE on or off:

- On the TEST MODE sub-menu, highlight the ON/OFF sub-menu and then press  key to access it.
- Under ON/OFF sub-menu the test mode can be set to one of the following options, using the left and right arrow keys:
 - OFF: when this value is chosen the Test Mode amber LED will not illuminate.
 - WITH SOUNDERS: when this value is chosen the amber Test Mode LED will illuminate.
 - WITHOUT SOUNDERS: when this value is chosen the Test Mode amber LED will illuminate.

Note: Selecting WITH SOUNDERS or WITHOUT SOUNDERS will activate the TEST MODE function, so that any Zones set for this mode can be tested.

Note: Selecting OFF will de-activate the TEST MODE function so that any Zones set for this mode will still activate Fire Alarms in the standard way.

- Select one of the above options and then press  key to activate it.
- Next, press the return  key to return to TEST MODE menu.

TEST MODE: SETTINGS

With this menu, the Zone(s) to be tested can be set.

To select the TEST MODE settings:

- On the TEST MODE sub-menu, highlight the SETTINGS sub-menu and then press ✓ key to access it.
- Under TEST SETTINGS sub-menu, the following options will be displayed:
 - 1: ZONES:
 - 2: INCLUDE ALL ZONES
 - 3: EXCLUDE ALL ZONES
- Use the up/down arrow keys to highlight the required option and press ✓ key to select it
- On selecting option 1, ZONES, the following sub-menu will be displayed:

```
TEST SETTINGS                <ZONE 1 – 8>
ZONE STATUS: TESTING/EXCLUDED
```
- Use the left/right arrow keys to select the required zone
- Press ✓ key to toggle between EXCLUDED or TESTING, press the return ↵ key to return to TEST SETTINGS menu
- Use the Up/Down arrow keys to highlight option 2, INCLUDE ALL ZONES, and press ✓ key to select it. A confirmation dialog, with options for NO/YES, will appear. Use Left/Right arrow keys to highlight the appropriate option and press ✓ key once. A short acknowledgement sound will be present
- Use the Up/Down arrow keys to highlight the EXCLUDE ALL ZONES option and press ✓ key to select it. A confirmation dialog, with options for NO/YES, will appear. Use Left/Right arrow keys to highlight the appropriate option and press ✓ key once. A short acknowledgement sound will be present
- Next, press the return ↵ key to return to TEST MODE menu.
- Press the return ↵ key to return to User Menu.

User Menu: TIME & DATE

The Time & Date and Set DST sub-menus are used to set the system clock and the local Daylight Savings Time (DST).

User TIME & DATE Menu: TIME & DATE

To set the system Time & Date:

- On the Main Menu, use Left/Right arrow keys to move cursor box to User menu
- Press ✓ key to select the User menu.
- Under User menu highlight the Time & Date option icon and press ✓ key to select it.

- On the User Time & Date sub-menu, highlight the Time & Date option and press ✓ key to access it.
- Adjust the time and date as required, using the Up/Down and Left/Right arrow keys.
- Press return  key once to return to Time & Date menu.

User TIME & DATE Menu: Set DST

To set the start and end of local Daylight Savings Time on the system:

- On the Main Menu, use Left/Right arrow keys to move cursor box to User menu
- Press ✓ key to select the User menu.
- Under User menu, highlight the Time & Date option and press ✓ key to select it.
- On the User Time & Date sub-menu, highlight Set DST option and press ✓ key to access it.
- The Set DayLight Savings Menu sub-menu the following options will be displayed:

Set DayLight Savings Menu

Starts: LAST Sunday MAR

Ends: LAST Sunday OCT

Auto Update DayLight Savings: YES

DST: ACTIVE/INACTIVE

- To change the Set DayLight Savings Menu sub-menu options, to match local start and end of DST:
 - Use Left/Right arrow keys to move between the various fields (indicated by underline cursor). Use Up/Down arrow keys to toggle to the required setting for each field:
 - Starts: LAST/1st/2nd/3rd/4th Monday – Sunday JAN – DEC - adjust the date, to show when the local Day Light Savings time begins (e.g. – Starts: Last Sunday MAY)
 - Ends: LAST/1st/2nd/3rd/4th Monday – Sunday JAN – DEC - adjust the date, to show when the local Day Light Savings time ends (e.g. – Ends: 4th Tuesday OCT)
 - Auto Update DayLight Savings: YES/NO – adjust to turn on or off the automatic switching of the system clock forward by 1 hour to match local DST
 - DST: ACTIVE / IN-ACTIVE – not amendable, automatically shows the current DST state dependent on the above settings.
- Press return  key once to return to Time & Date menu.

User Menu: LAMP TEST

To operate the Lamp Test menu, to test the panel LCD display and warning LEDs:

- On the Main Menu, use Left/Right arrow keys to move cursor box to User menu
- Press ✓ key to select the User menu.
- Under User menu highlight the Lamp Test option, and then press ✓ key to select it.
- This action will enable the lamp test mode: a long acknowledgement sound will be present, the digital display will turn blank (allowing the observation of any damaged pixels on the screen), and all LEDs on the front fascia will come on, following this sequence:
 - First, the following LEDs will come on, at the same time, for a couple of seconds:
 - General Alarm
 - General Fault
 - Supply Healthy
 - Rain Status
 - Disablement
 - Power Supply Fault
 - Sounder Status
 - Test Mode
 - System Fault
 - Second, the following Vent active LEDs will come on, at the same time, for a couple of seconds (the number of LEDs that come on depends on the AOV Cards fitted to the panel and the vents connected in the system):
 - Vent 1 active to Vent 8 active
 - Third, the following Vent fault LEDs will come on, at the same time, for a couple of seconds (the number of LEDs that come on depends on the AOV Cards fitted to the panel and the vents connected in the system):
 - Vent 1 fault to Vent 8 fault

Note: After the lamp test has been performed, the LCD digital display will turn back ON (displaying the User Menu), after all LEDs have extinguished and the long acknowledgement sound has stopped.

User Menu: CONTRAST

To set the LCD screen contrast and backlight, operate the Contrast menu:

- On the Main Menu, use Left/Right arrow keys to move cursor box to User menu
- Press ✓ key to select the User menu.
- Under User Menu highlight the Contrast option, and then press ✓ key to select it.
- Under the Contrast Menu sub-menu, the two following options will be available:
 - Contrast: use the left and right arrow keys to adjust the value
 - BACKLIGHT: using the up and down arrow keys, one of the following values can be set: MIN, HALF, and MAX
- Press return  key to return to User menu. A short acknowledgement sound will be present.

User Menu: BUZZER

To set the volume for the panel internal buzzer, operate the BUZZER menu:

- On the Main Menu, use Left/Right arrow keys to move cursor box to User menu
- Press ✓ key to select the User menu.
- Under User Menu, highlight the BUZZER option and then press ✓ key to select it.
- Under BUZZER Menu the following option will be available:
 - VOLUME - which can be adjusted using the left and right arrow keys.
- Press return  key to return to User Menu. A short acknowledgement sound will be present.

User Menu

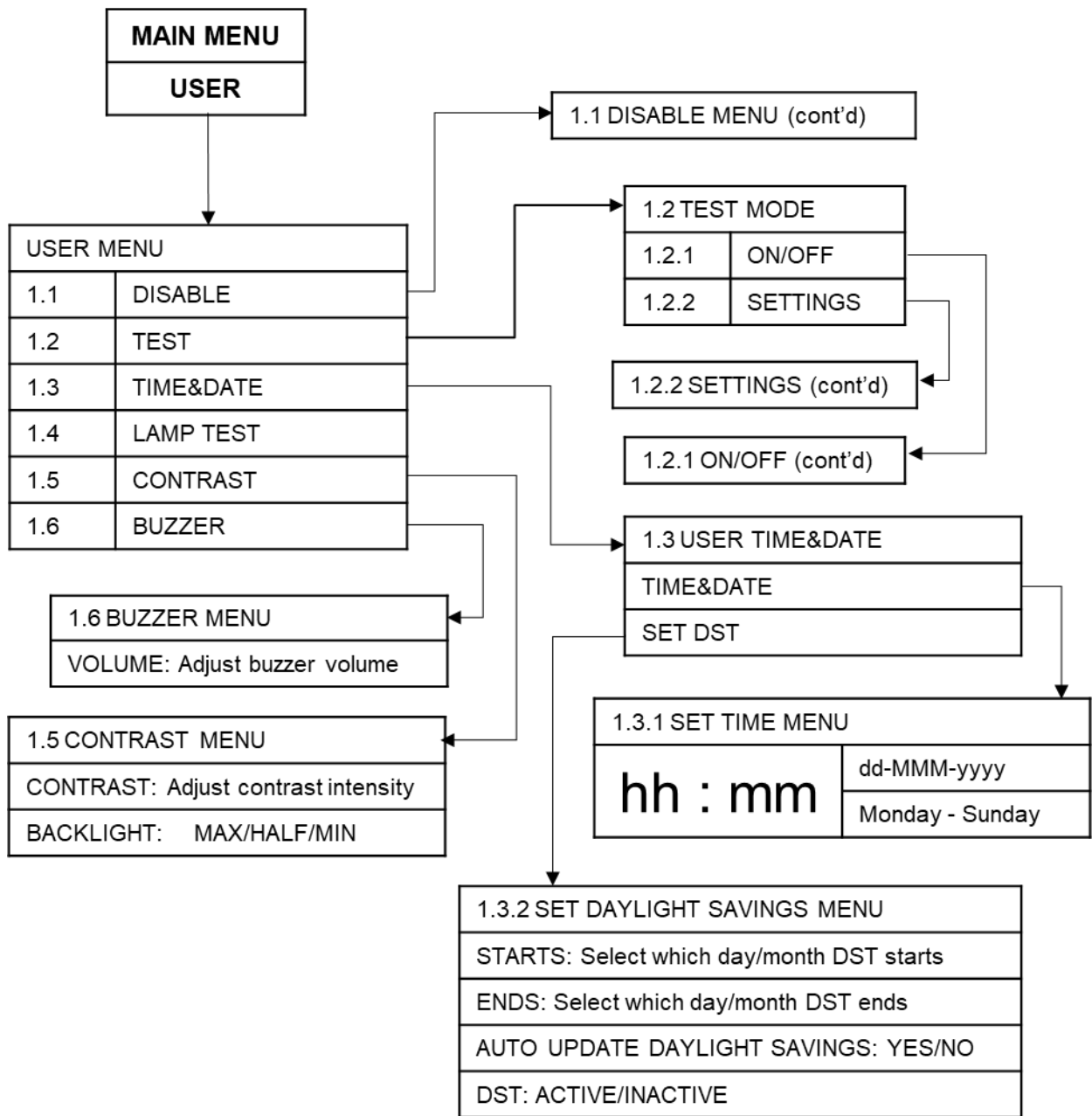

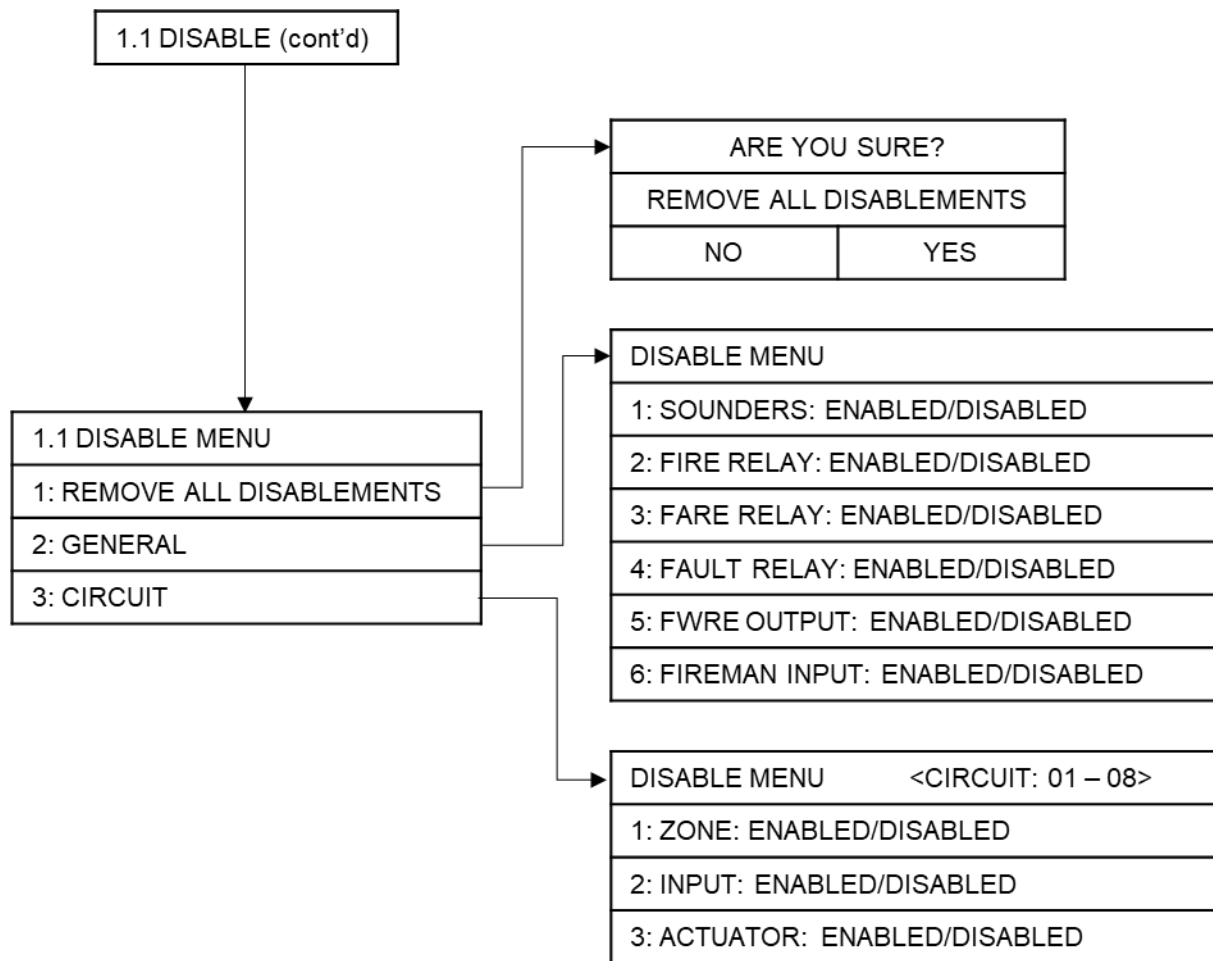

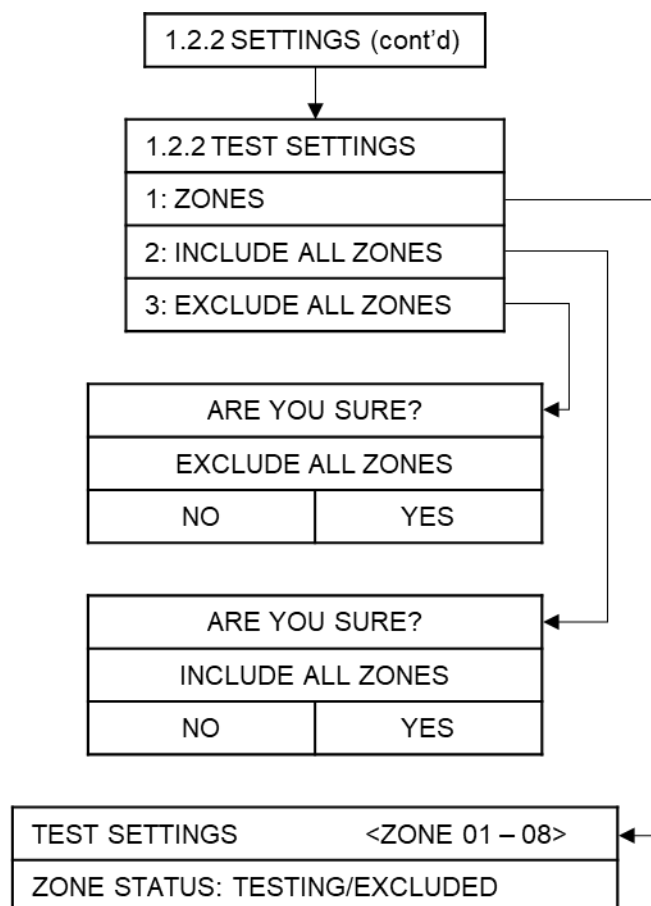
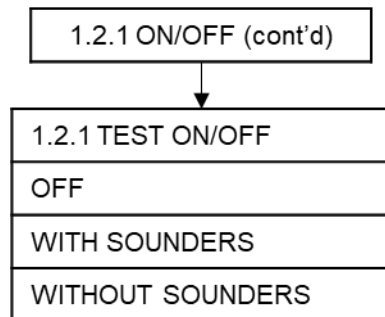

CONFIG Menu

Accessible from the Main Menu (Access level 2); the CONFIG Menu (Access level 3), and its subsequent sub-menus, are used to configure the panel and its attached devices. The sub-menus available are:

- CONFIG
 - PANEL
 - LEARN
 - OPTIONS
 - DEFAULT
 - PASSWORD
 - CIRCUIT
 - DEVICES
 - VENT
 - ZONES
 - SOUNDERS
 - RELAY
 - PSU
 - P-BUS

To access the CONFIG menu:

- Turn Activate Controls Key to On

or

- Use the keypad to enter code 1111:
 - Press ✓ key
 - Use the Up/Down arrow keys to increase/decrease the number value
 - Use the Left/Right arrow keys to move to the next digit in the 4-digit sequence
 - When all 4 digits have been set to the code 1111 press ✓ key once again. The MAIN MENU will become available for operation
- On the MAIN MENU, use Left/Right arrow keys to move cursor box to CONFIG icon
- Press ✓ key to select the CONFIG icon. The digital display will show the following message:

Enter Level 3 Access Code
- Use the keypad to enter code 3333:
 - Press ✓ key
 - Use the Up/Down arrow keys to increase/decrease the number value
 - Use the Left/Right arrow keys to move to the next digit in the 4-digit sequence

- When all 4 digits have been set to the code 3333 press ✓ key once again. The Access level 3 menu will become available for operation.

Note: Access level 3 Menu will deactivate after 30 sec if not used.

CONFIG Menu: PANEL

To configure the Panel controls and outputs:

CONFIG PANEL Menu: LEARN

To set the panel to automatically learn what internal cards and Peripheral BUS (P-BUS) RSUs are connected to the system, access the LEARN PANEL menu:

Note: Running a learning routine will overwrite any device configuration previously set.

- On the CONFIG Menu, highlight PANEL option and then press ✓ key to gain access to it.
- Next highlight the LEARN option, under the CONFIG PANEL menu and press ✓ key to select it.
- The system will perform a learning routine; to acknowledge the Internal Cards installed in the panel and the P-BUS (Peripheral BUS, which is achieved using a RS485 network) connection. The following information will be displayed in turn, each accompanied by a progress bar:

LEARNING INTERNAL CARDS:

LEARNING P-BUS:

- On completion of the learning routine, the LEARN PANEL sub-menu will display all the internal cards, devices and RSUs that were found available:
 - INTERNAL CARDS: The LEARN PANEL menu will display the internal cards found connected, or not, indicated by YES or NO:

LEARN PANEL

-INTERNAL CARDS-

1: PSU CARD: YES/NO

2: AOV CARD ONE: YES/NO

3: AOV CARD TWO: YES/NO

4: AOV CARD THREE: YES/NO

5: AOV CARD FOUR: YES/NO

6: Relay ONE: YES/NO

7: Relay TWO: YES/NO

- Press return  key to accept.

- P-BUS: The LEARN PANEL sub-menu will display a list containing all 32 of the possible RSUs that could be connected, using the P-BUS, and show if they are connected or not - indicated by PRESENT or NOT PRESENT:

LEARN PANEL

-P-BUS-

1: 1st RSU: PRESENT/NOT PRESENT

to

32: 32nd RSU: PRESENT/NOT PRESENT

- Press the return  key to finally accept. A short acknowledgement sound will be present.

Note - any differences, between detected devices and changes made by user, will result in a System Fault condition. The General Fault and System Fault status LEDs will be illuminated pulsing, with an accompanying fault tone from the internal buzzer. Additionally, on return to the Title screen, a FAULT display will list the applicable faults. This condition will require the panel to be re-configured to clear.

CONFIG PANEL Menu: OPTIONS

To configure the panel sounder and vent closure on power up and power failure options, access the PANEL OPTIONS menu:

- On the CONFIG Menu, highlight PANEL option and then press ✓ key to gain access to it.
- Highlight the OPTIONS icon under the CONFIG PANEL menu and press ✓ key again.
- The information available under OPTIONS sub-menu will be presented as follows:

PANEL OPTIONS

1: ZONES RESOUND 2ND ALARM: YES/NO

2: SOUNDER ONE FARE: YES/NO

3: SOUNDER TWO FWRE: YES/NO

4: DELAY DEPENDENCY: DISABLED/TYPE A/TYPE B/TYPE C

5: CONFIRM TIME: 0 MIN 0 SEC

6: INHIBITED TIME: 0 MIN 0 SEC

7: CLOSE VENT ON POWER UP: YES/NO

8: MAINS FAIL CLOSE VENT: DISABLED/30 MINS/60 MINS/90 MINS/120 MINS

9: ONE ZONE CARD: YES/NO

- Use the Up/Down arrow keys to move between the options 1 to 9
- For options 1 to 4, 7 and 9; press enter ✓ key to toggle between YES or NO, as required.

- For options 5, 6 and 8; press enter ✓ key to enable changes, then use Up/Down arrow keys to toggle between the various time parameters, as required.

Note: If SOUNDER ONE FARE and/or SOUNDER TWO FWRE (options 2 and 3) are set to YES, their status (NORMAL/ACTIVE) will be displayed on the LCD screen title display, and in place of the event counts (A nn F nn D nn T nn O nn) on any of the EVENT reports (ALARM, FAULT, DISABLE, TEST and OTHER).

Note: If SOUNDER TWO FWRE (option 3) is set to YES, faults on the SOUNDER TWO circuit will NOT be indicated (all other fault indications are unaffected). This feature does not conform with BS EN 54-2, clause 8.2.4 g) and clause 8.9.

Note: Options 5 and 6 displays change, depending on the delay dependency selected in option 4:

- If TYPE A is selected, CONFIRM TIME (option 5) can be amended between 1 MIN 0 SEC and 10 MIN 0 SEC in 30 sec increments. INHIBITED TIME (option 6) defaults to 0 MIN 30 SEC and cannot be changed.
- If TYPE B is selected, CONFIRM TIME (option 5) can be amended between 5 MIN 0 SEC and 13 MIN 0 SEC in 30 sec increments. INHIBITED TIME (option 6) can be amended between 0 MIN 30 SEC and 4 MIN 0 SEC in 30 sec increments.
- If TYPE C or DISABLED are selected, CONFIRM TIME (option 5) and INHIBITED TIME (option 6) default to 0 MIN 0 SEC and cannot be changed.

Note: With option 7 (CLOSE VENT ON POWER UP) set to YES; upon power up of the system, all vents will be set to the closed state, irrespective of their current open/closed position or switch setting. This enables all vents to be set to a conformal position.

Note: Option 8 sets a time delay of between 30 and 120 minutes, after which all the vents are closed (irrespective of their current position or switch setting), following mains power failure. After the vents have been closed, they will remain closed unless opened by the Fireman's switch. All local vent control switches are disabled. If set to DISABLED, all vents and local vent control switches remain fully operational following mains power failure.

Note: Option 9 configures the panel for use as a single zone panel, when PCA028-SZ is installed.

- Next, press the return ↵ key once to accept all changes and to return to CONFIG PANEL menu. A short acknowledgement sound will be present.

CONFIG PANEL Menu: DEFAULT

To return the panel to its factory default settings, access the DEFAULT menu:

Highlight PANEL option and then press ✓ key in order to gain access to it.

Highlight the DEFAULT option under the CONFIG PANEL menu and press ✓ key again.

The following information will be displayed on the digital display:

```

ARE YOU SURE?
SET DEVICE DEFAULTS
NO             YES

```

- Use the Left/Right arrow keys to choose between YES or NO options and then press ✓ key in order to enable your action.
- If NO value has been selected, then the system will return to CONFIG PANEL menu and the current settings will be maintained.

- If YES value has been selected, then all current settings will be overwritten, and the system will return to original factory settings.

Caution is recommended before choosing the YES value for the DEFAULT option! Choosing this option will remove ALL configuration that has been set and will return the panel to its factory default settings.

- Press the return  key once to return to CONFIG PANEL menu. A short acknowledgement sound will be present.

CONFIG PANEL Menu: Password

To set the 4-digit access codes, access the Password menu:

- Highlight PANEL option and then press ✓ key in order to gain access to it.
- Highlight the Password option under the CONFIG PANEL menu and press ✓ key again.
- The Set Password Menu will be presented as follows:

OLD User Password: 1111	Back
User Password: 0000	Confirm
- Use the Up/Down arrow keys to increase/decrease the number value
- Use the Left/Right arrow keys to move to the next digit in the 4-digit sequence
- When all 4 digits have been set to the required new code press ✓ key once again.
- Press the return  key once to return to Panel menu.

CONFIG Menu: CIRCUIT

To configure inputs from circuits (zone (detector), vent, local vent control switch, PIR, Rain, etc.) connected to the system:

CONFIG CIRCUIT Menu: CONFIG CIRCUIT

To configure the various circuits connected to the system via the AOV Card(s), access the CIRCUIT menu:

- On the CONFIG Menu, highlight the CIRCUIT icon and then press ✓ key to gain access to it.
- The CONFIG CIRCUIT menu options will be presented as follows:

```
CONFIG CIRCUIT          <AREA 01 – 08>
1: ZONE CIRCUIT: NORMAL, TWIN WIRE, NOT USED
2: INPUT CIRCUIT: ENABLED, NOT USED
3: VENT CIRCUIT: MONITORING, S/C NOT MON, NOT USED
4: SWITCH CIRCUIT: NORMAL, FIREMAN, NOT USED
5: PIR CIRCUIT: ENABLED, NOT USED
6: RAIN CIRCUIT: ENABLED, NOT USED
```

7: 2nd MAINS INPUT: ENABLED, NOT USED

- Use the Left/Right arrow keys to toggle between the circuit AREA (01 – 08, depending on the AOV Cards fitted), to select the required Area
- Use Up/Down arrow keys to move between options 1 – 7, as required
- For each of the options 1 to 7, press enter ✓ key to toggle between parameters, as required

Note: Option 1 refers to Normal/Twin Wire detector circuit (x1 per Area) – ZONE 1/ZONE 2 on AOV Card.



Note: Dependency modes are not compatible with Twin Wire mode.

Note: Option 2 is used for any additional inputs, not otherwise covered by Options 1 – 7, connected to AOV Card – INPUT 1/INPUT 2.

Note: Option 3 refers to AOV Card ACT 1/ACT 2 connections. Disabling the monitoring of short circuit faults might not be compliant with local regulations.

Note: Option 4 refers to Local Vent Control Switch (AOV Card inputs SWITCH 1/SWITCH 2), which can be configured to act as a Fireman's switch for its local vent, together with other vents, depending on configuration.

Note: Option 7 refers to the 2nd Mains input, on the PSU card (POWER IN B). Setting this parameter, irrespective of which Area (01 – 08) it is set in, affects the panel as a whole and only one parameter change is required.

- Press the return  key once to return to CONFIG Menu. A short acknowledgement sound will be present.
- Press the return  key once to return to Main Menu

CONFIG Menu: DEVICES

To configure external devices (call points, detectors, sounders, relays, vents, etc.) connected to the system:

CONFIG DEVICES Menu: VENT

To configure the vents connected to the system and the detector zones, external inputs and manual switch inputs that control them, access the VENT menu:

- On the CONFIG Menu, highlight DEVICES icon and then press ✓ key to gain access to it.
- Highlight the VENT option icon, under the CONFIG DEVICES sub-menu, and press ✓ key again.
- The CONFIG AOV VENT menu will be displayed:

CONFIG AOV VENT 01 – 08

1: OPENING TIME (Secs): 10 – 300 (in 5 sec increments)

2: CLOSING Time (Secs): 10 – 300 (in 5 sec increments)

3: ZONE CONTROL

CONFIG CONTROL VENT 01 – 08

1: ZONE ONE: OPEN VENT/CLOSE VENT/DISABLED

2: ZONE TWO: OPEN VENT/CLOSE VENT/DISABLED

to

8: ZONE EIGHT: OPEN VENT/CLOSE VENT/DISABLED

9: 1st RSU: DISABLED/ENABLED

to

40: 32nd RSU: DISABLED/ENABLED

4: INPUT CONTROL

CONFIG CONTROL VENT 01 – 08

1: INPUT ONE: OPEN VENT/CLOSE VENT/DISABLED

2: INPUT TWO: OPEN VENT/CLOSE VENT/DISABLED

to

8: INPUT EIGHT: OPEN VENT/CLOSE VENT/DISABLED

5: MANUAL CONTROL

CONFIG CONTROL VENT 01 – 08

1: MANUAL ONE: ENABLED/DISABLED

2: MANUAL TWO: ENABLED/DISABLED

to

8: MANUAL EIGHT: ENABLED/DISABLED

9: 1st RSU: DISABLED/ENABLED

to

40: 32nd RSU: DISABLED/ENABLED

6: THERMOSTAT OPENING: DISABLED/0% – 100% (in 10% increments)

7: THERMOSTAT CLOSING: DISABLED/0% – 100% (in 10% increments)

8: RAIN CONTROL: ENABLED/DISABLED

9: PIR CONTROL: ENABLED/DISABLED

10: BMS CONTROL: ENABLED/DISABLED

11: INVERT VENT OUTPUT: NO/YES

12: MAINTAIN VENT OUTPUT: NO/YES

13: INVERT AUX OUTPUT: NO/YES

- On the CONFIG VENT menu (CONFIG AOV VENT) and the CONFIG CONTROL sub-menus, at Options 3, 4 and 5, use the Left/Right arrow keys to toggle between the VENT to be configured (01 – 08, depending on the AOV Cards fitted).

- For options 3, 4 and 5; press enter ✓ key to access their CONFIG CONTROL sub-menus.
- For option 1: OPENING TIME and option 2: CLOSING TIME; press ✓ key to access change time control. Use Up/Down arrow keys to toggle through time in 5 sec increments. Press ✓ key to lock change.
- On the CONFIG VENT menu (CONFIG AOV VENT) and the CONFIG CONTROL sub-menus, at Options 3, 4 and 5, use Up/Down arrow keys to move between options, as required.
- For option 6: THERMOSTAT OPENING and option 7: THERMOSTAT CLOSING; press ✓ key to access change control. Use Up/Down arrow keys to toggle through thermostat position in 10% increments. Press ✓ key to lock change.
- For CONFIG VENT menu (CONFIG AOV VENT) options 8, 9, 10, 11, 12 and 13, and the CONFIG CONTROL sub-menus' options, at Options 3, 4 and 5, press enter ✓ key to toggle between parameters, as required.
- Press the return ↵ key once to return to CONFIG Menu. A short acknowledgement sound will be present.
- Press the return ↵ key once to return to Main Menu

CONFIG DEVICES Menu: ZONES

To configure the parameters for the system zones, access the ZONES menu:

- On the CONFIG Menu, highlight DEVICES icon and then press ✓ key in order to gain access to it.
- Use Left/Right arrow keys to highlight the ZONES option icon, under the CONFIG DEVICES sub-menu, and press ✓ key again.
- The CONFIG ZONES menu will be displayed:

```

CONFIG ZONES    <ZONE 01 – 08>
1: LATCH ALARM: YES/NO
2: S/C TRIGGERS ALARM: YES/NO
3: INTRINS SAFE: YES/NO
4: PRIORITY ALARM: ENABLED/DISABLED
5: HEAD REMOVAL: ENABLED/DISABLED
6: DEPENDENCY MODE: ENABLED/DISABLED
7: LATCH INPUT: YES/NO
8: S/C TRIGGERS INPUT: YES/ NO

```

Note: S/C = Short Circuit.

Note: Dependency mode is not applicable with Twin Wire mode.

- Use the Left/Right arrow keys to toggle between the ZONES (01 – 08, depending on the AOV Cards fitted).

- Use Up/Down arrow keys to move between options 1 – 8, as required
- For each of the options 1 to 8, press enter ✓ key to cycle through parameters, as required
- Press the return ↵ key once to return to CONFIG Menu. A short acknowledgement sound will be present.
- Press the return ↵ key once to return to Main Menu

CONFIG DEVICES Menu: SOUNDERS

To configure the various sounder outputs for the system, access the SOUNDERS menu:

- On the CONFIG Menu, highlight DEVICES sub-menu and then press ✓ key to gain access to it.
- Highlight the SOUNDERS option under the DEVICES sub-menu, and press ✓ key again.
- The CONFIG SOUNDERS sub-menu will be presented as follows:
CONFIG SOUNDER <PSU SNDR ONE/TWO> -
1: IN ALARM: OFF/PULSING/CONTINUOUS
2: IN EVAC: OFF/PULSING/CONTINUOUS
3: IN DELAY: OFF/PULSING/CONTINUOUS
4: SOUNDER CAN BE SILENCED: YES/NO
- Use Left/Right arrow keys to toggle between PSU SNDR ONE and TWO
- Use Up/Down arrow keys to move between options 1 – 4.
- For each of the sounder circuits, press ✓ key to toggle between parameters for each option, as required.
- Press the return ↵ key once to return to CONFIG DEVICES menu. A short acknowledgement sound will be present.

CONFIG DEVICES Menu: Relay

To access the Relay menu:

- On the CONFIG Menu, highlight DEVICES icon and then press ✓ key in order to gain access to CONFIG DEVICES menu.
- Highlight the **Relay** option under the CONFIG DEVICES sub-menu, and press ✓ key again.
- The information available under CONFIG Relay sub-menu will be presented as follows:
CONFIG Relay <FIRE/FAULT>
1: IN ALARM: OFF/PULSING/CONTINUOUS
2: IN EVAC: OFF/PULSING/CONTINUOUS
3: IN FAULT: OFF/PULSING/CONTINUOUS

4: FAIL SAFE: YES/NO

5: CAN BE SILENCED: YES/NO

- Use Left/Right arrow keys to toggle between relays FIRE and FAULT
- Use Up/Down arrow keys the move between options 1 – 5.
- For each of the relays, press ✓ key to toggle between parameters for each option, as required.
- Press the return ↵ key once to return to CONFIG DEVICES menu. A short acknowledgement sound will be present.

CONFIG Menu: PSU

To configure Power Supply Unit settings, access the PSU menu:

- From the CONFIG Menu, highlight PSU option and then press ✓ key in order to gain access to it.
- The information available under CONFIG PSU option will be presented as follows:

CONFIG PSU

1: BATTERY MONITORING: YES/NO

2: BATTERY HIGH-Z MONITORING: YES/NO

3: CHARGE DURING ALARM: YES/NO

4: EARTH FAULT MONITORING: YES/NO

5: UPS MODE: YES/NO

6: LOW CHARGE CURRENT: YES/NO

- Use the up/down arrow keys to navigate between options 1 – 6.
- Press ✓ key to change between YES or NO values, as required, for each option.
- Press the return ↵ key once to return to CONFIG Menu. A short acknowledgement sound will be present.
- **Note:** The configuration of Power Supply Unit Settings function allows compliance with BS EN 54-2:1997 + A1:2006.
- **Note:** Setting BATTERY MONITORING (option 1) to NO disables both battery monitoring and battery charging. This is NOT compliant with BS EN 54-2.

CONFIG Menu: P-BUS

If RSU(s) have been added or removed from the P-BUS, since the last configuration learning routine, the RSUs on the P-BUS can be configured from the P-BUS menu:

- From the CONFIG Menu, highlight P-BUS option and then press ✓ key in order to gain access to it.
- The information available under CONFIG P-BUS menu will be presented as follows:

CONFIG P-BUS

-P-BUS-

1: 1st RSU: PRESENT/NOT PRESENT

2: 2nd RSU: PRESENT/NOT PRESENT

to

32: 32nd RSU: PRESENT/NOT PRESENT

- Use the Up/Down arrow keys to select which RSUs are to be configured.
- Press ✓ key to change between PRESENT or NOT PRESENT values.
- Press the return  key once to return to CONFIG DEVICES menu. A short acknowledgement sound will be present.

Note: Any differences, between detected devices and changes made by user, will result in a General Fault condition. The General Fault status LED will be illuminated pulsing, with an accompanying fault tone from the internal buzzer. Additionally, on return to the Title screen, a FAULT display will list the applicable faults (i.e. '1: RSU RSU 01 OFFLINE'). This condition will require the panel to be re-configured to clear.

CONFIG Menu

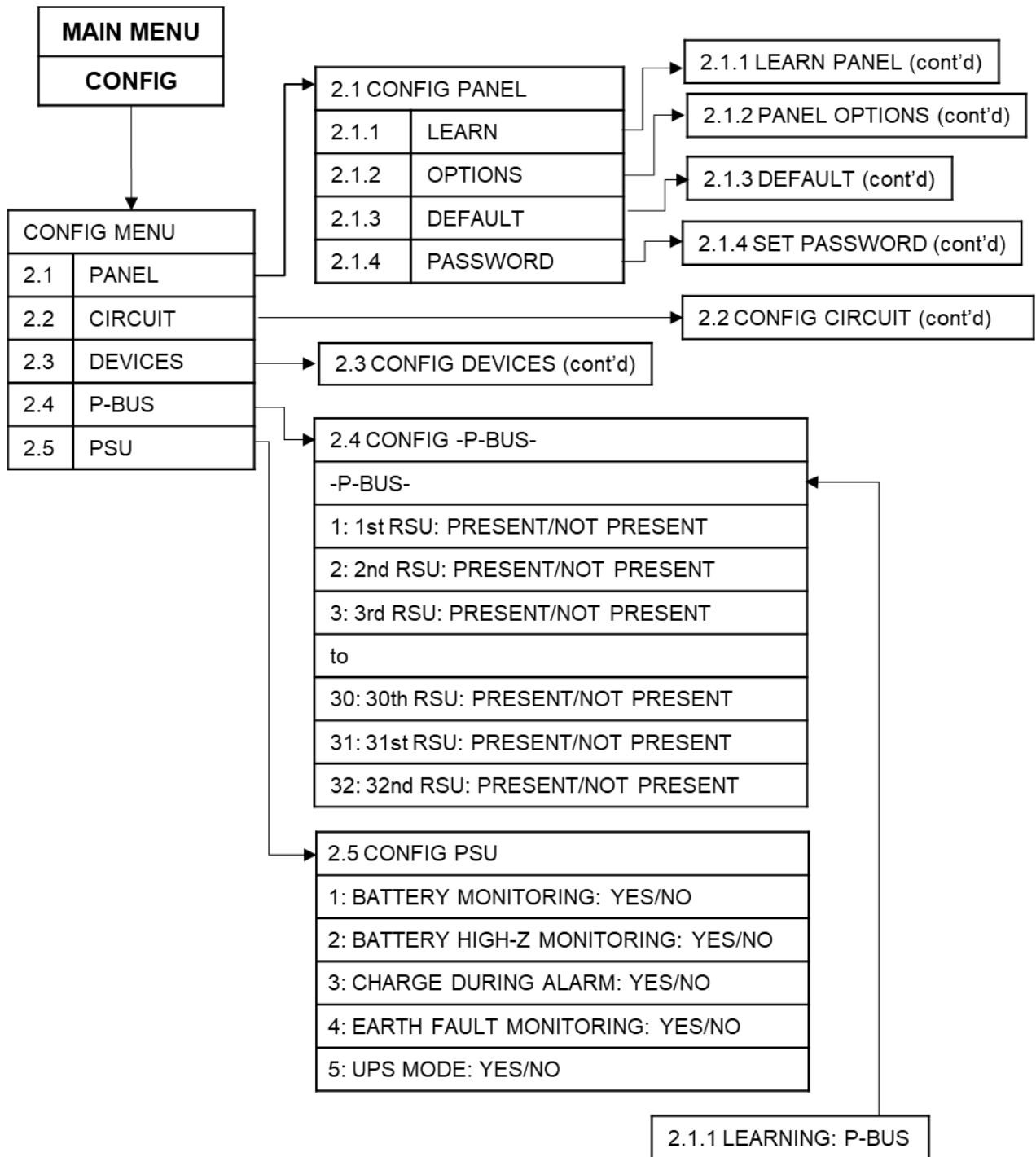

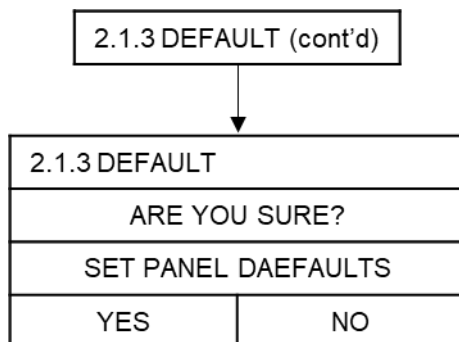
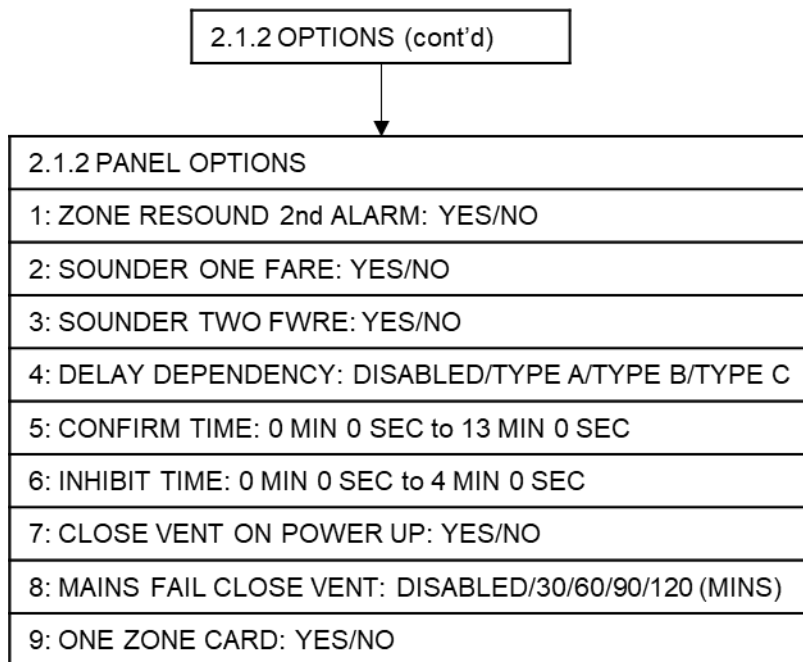
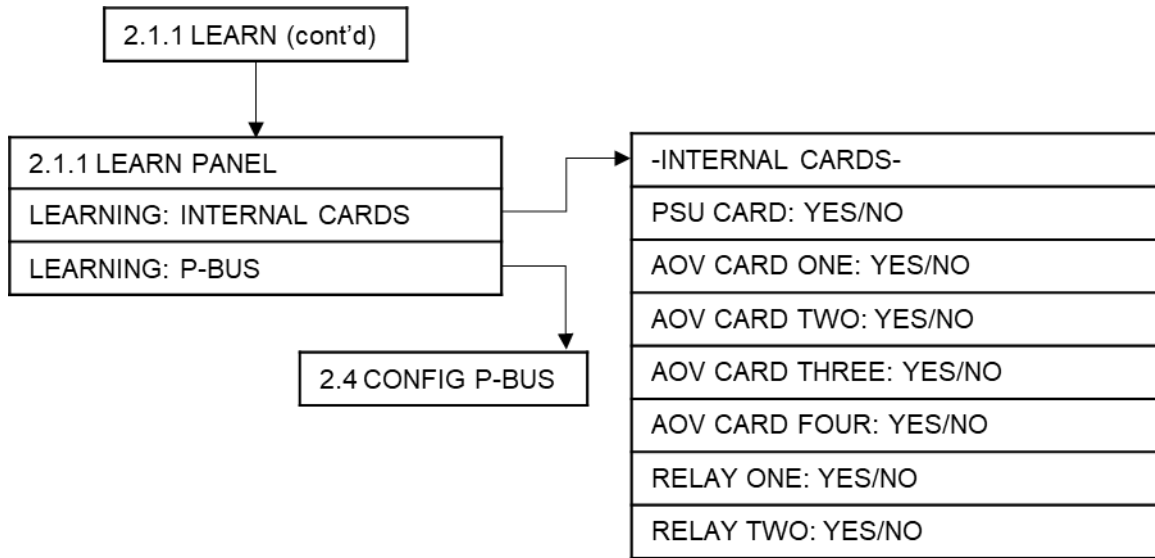

2.1.4 PASSWORD (cont'd)



2.1.4 SET PASSWORD	
OLD USER PASSWORD: nnnn (1 – 9)	BACK
USER PASSWORD nnnn (1 – 9)	CONFIRM

2.2 CIRCUIT (cont'd)

2.2 CONFIG CIRCUIT

CONFIG CIRCUIT	<AREA 01-08>
1: ZONE CIRCUIT: NORMAL, TWIN WIRE, NOT USED	
2: INPUT CIRCUIT: ENABLED, NOT USED	
3: VENT CIRCUIT: MONITORING, S/C NOT MON, NOT USED	
4: SWITCH CIRCUIT: NORMAL, FIREMAN, NOT USED	
5: PIR CIRCUIT: ENABLED, NOT USED	
6: RAIN CIRCUIT: ENABLED, NOT USED	
7: 2nd MAINS INPUT: ENABLED, NOT USED	

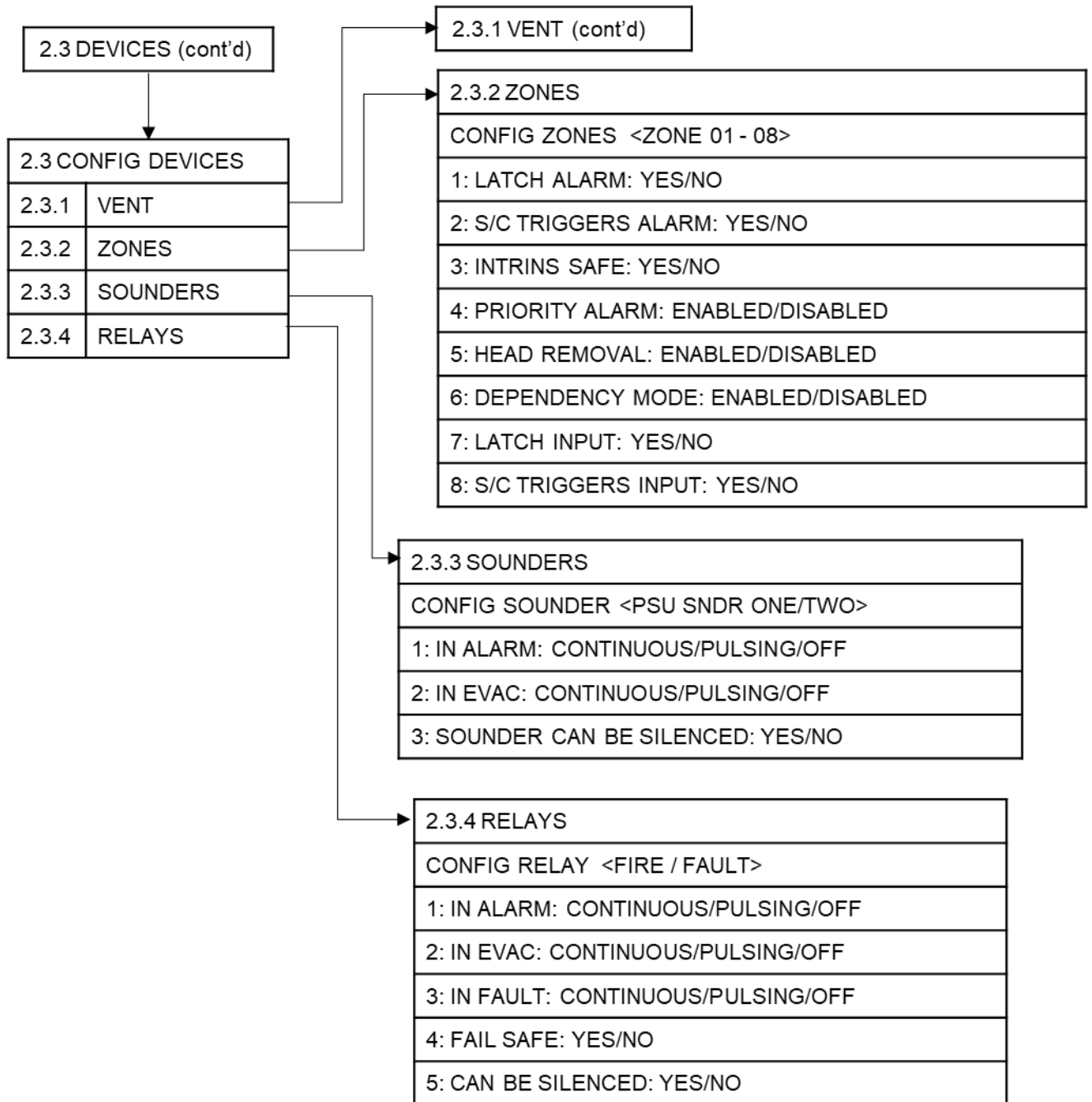

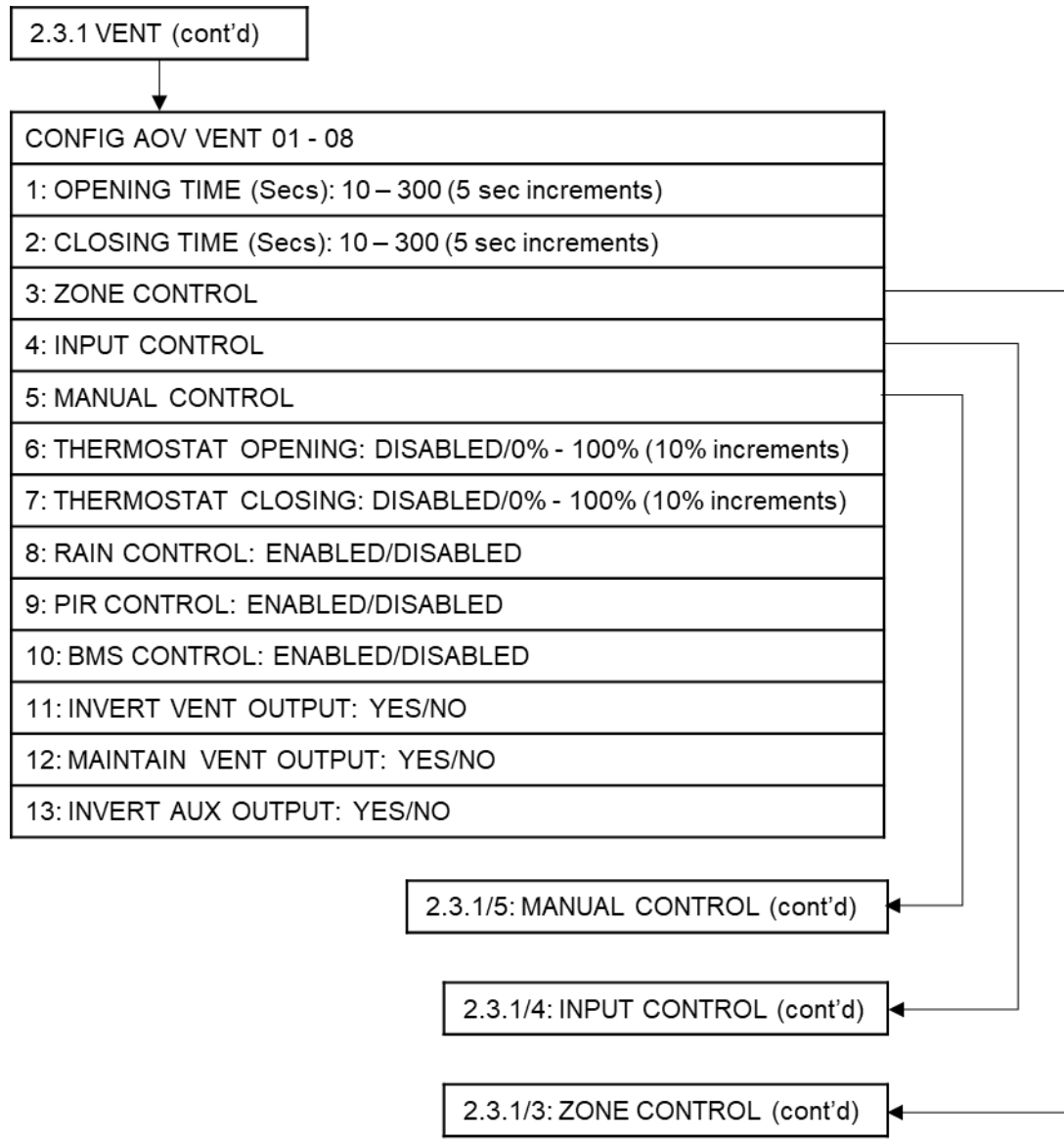

2.3.1/3: ZONE CONTROL (cont'd)

CONFIG CONTROL VENT 01 - 08
1: ZONE ONE: OPEN VENT/CLOSE VENT/DISABLED
2: ZONE TWO: OPEN VENT/CLOSE VENT/DISABLED
to
7: ZONE SEVEN: OPEN VENT/CLOSE VENT/DISABLED
8: ZONE EIGHT: OPEN VENT/CLOSE VENT/DISABLED
9: 1st RSU: DISABLED/ENABLED
10: 2nd RSU: DISABLED/ENABLED
to
39: 31st RSU: DISABLED/ENABLED
40: 32nd RSU: DISABLED/ENABLED

2.3.1/4: INPUT CONTROL (cont'd)

CONFIG CONTROL VENT 01 - 08
1: INPUT ONE: OPEN VENT/CLOSE VENT/DISABLED
2: INPUT TWO: OPEN VENT/CLOSE VENT/DISABLED
to
7: INPUT SEVEN: OPEN VENT/CLOSE VENT/DISABLED
8: INPUT EIGHT: OPEN VENT/CLOSE VENT/DISABLED

2.3.1/5: MANUAL CONTROL (cont'd)

CONFIG CONTROL VENT 01 - 08
1: MANUAL ONE: DISABLED/ENABLED
2: MANUAL TWO: DISABLED/ENABLED
to
7: MANUAL SEVEN: DISABLED/ENABLED
8: MANUAL EIGHT: DISABLED/ENABLED
9: 1st RSU: DISABLED/ENABLED
10: 2nd RSU: DISABLED/ENABLED
to
39: 31st RSU: DISABLED/ENABLED
40: 32nd RSU: DISABLED/ENABLED

Report Menu

From the Report menu, on the Main Menu, the following sub-menus are available:

- REPORT
 - EVENTS
 - ALARM
 - FAULT
 - DISABLE
 - TEST
 - OTHER
 - STATUS
 - AOV
 - PSU Card
 - BATTERY
 - HISTORY
 - COUNTER
 - Versions

To access the REPORT menu:

- Turn Activate Controls Key to On

or

- Use the keypad to enter code 1111:
 - Press ✓ key
 - Use the Up/Down arrow keys to increase/decrease the number value
 - Use the Left/Right arrow keys to move to the next digit in the 4-digit sequence
 - When all 4 digits have been set to the code 1111 press ✓ key once again. The MAIN MENU will become available for operation

Note: Access level 2 Menu will deactivate after 30 sec if not used.

- Fault info will be displayed in the following manner:

FAULT A 00 F nn D 00 T 00 O 00

List of detected faults

or

FAULT FWRE : NORMAL/ACTIVE and/or FARE : NORMAL/ACTIVE

List of detected faults

(Displayed if Sounder One FARE and/or Sounder Two FWRE are selected to YES, under CONFIG > PANEL > OPTIONS, during configuration)

Where:

A means Alarm

F means Faults

D means Disablement

T means Test

O means Other

- Press the return  key or ✓ key to return to the Main Menu display.

Report EVENTS Menu: DISABLE

To get DISABLE events information on system disablements:

- On the Main Menu, use Left/Right arrow keys to move cursor box to Report menu
- Press ✓ key to select the Report menu.
- Under Report Menu, highlight the EVENTS sub-menu and press ✓ key to select it
- Under Report EVENTS sub-menu, select DISABLE option and press ✓ key to select it.
- DISABLE info will be displayed in the following manner:

DISABLE A 00 F 00 D nn T 00 O 00

List of detected disablements

or

DISABLE FWRE : NORMAL/ACTIVE and/or FARE :
NORMAL/ACTIVE

List of detected disablements

(Displayed if Sounder One FARE and/or Sounder Two FWRE are selected to YES, under CONFIG > PANEL > OPTIONS, during configuration)

Where:

A means Alarm

F means Faults

D means Disablement

T means Test

O means Other

- Next, press return  key or ✓ key to return to the Main Menu display.

Report EVENTS Menu: TEST

To open a report screen for TEST events information:

- On the Main Menu, use Left/Right arrow keys to move cursor box to Report menu
- Press ✓ key to select the Report menu.
- Under Report Menu, highlight the EVENTS sub-menu and press ✓ key to select it
- Under Report EVENTS sub-menu, select TEST option and press ✓ key to select it.
- TEST info will be displayed in the following manner:

```
TEST          A 00  F 00  D 00  T nn  O 00
```

List of detected events

or

```
TEST          FWRE : NORMAL/ACTIVE and/or FARE : NORMAL/ACTIVE
```

List of detected events

(Displayed if Sounder One FARE and/or Sounder Two FWRE are selected to YES, under CONFIG > PANEL > OPTIONS, during configuration)

Where:

A means Alarm

F means Faults

D means Disablement

T means Test

O means Other

- Next, press return  key or ✓ key to return to the Main Menu display.

Report EVENTS Menu: OTHER



To obtain a report on OTHER events information (any events not covered under ALARM, FAULT, DISABLE or TEST – e.g. Non-Fire alarm events):

- On the Main Menu, use Left/Right arrow keys to move cursor box to Report menu
- Press ✓ key to select the Report menu.
- Under Report Menu, highlight the EVENTS sub-menu and press ✓ key to select it
- Under Report EVENTS sub-menu, select OTHER option and press ✓ key to select it.

- Next, press return  key to return to Report STATUS menu.

Report STATUS Menu: PSU Card

To get status information for the panel's PSU card, access the PSU Card Status menu:

- On the Main Menu, use Left/Right arrow keys to move cursor box to Report menu.
- Press  key to select the Report menu.
- Under Report Menu, select the STATUS option and then press  key to access it.
- Under Report STATUS sub-menu highlight the PSU Card option, and then press  key to select it.
- PSU Card Status menu will display information related to; the power supply of the system and any external devices connected to the PSU card, similar to:



PSU Card STATUS

TEMP	nnnn	nn.nn		INP1	nnnn	INP2	nnnn
MAI	NO	VL	NO	SNDR1	nnnn	SNDR2	nnnn
BAT	NO	IMP	NO	BATV	nnnn	BATM	nnnn
DIS	NO	EAR	NO	VIN1	nnnn	VIN2	nnnn
ONL	nnnn		nnnn	REF28	nnnn	EART	nnnn
Z-	nnnn	n		CHRG	nnnn	S	nnnn
						NMON	nnnn

- Next, press return  key to return to the Report STATUS menu.

Report STATUS Menu: BATTERY

To get status information on the system's battery, access the Battery Status menu:

- On the Main Menu, use Left/Right arrow keys to move cursor box to Report menu.
- Press  key to select the Report menu.
- Under Report menu select the STATUS option and then press  key to access it.
- Under Report STATUS sub-menu highlight the BATTERY option, and then press  key to select it.
- The BATTERY STATUS menu will display information, similar to the following:

BATTERY STATUS

TEMPERATURE: nn.nn

BATTERY VOLTS: nn.nn



CHARGE: nn.nn

Current: n.nn

DAC OUTPUT: nnn.nn

VREF INT: nnnn

CALIBRATION: n.nnnnnn

- Next, press return  key or  key to return to the Report STATUS menu. A short acknowledgement sound will be present.

Report Menu: HISTORY

To access EVENT HISTORY information:

- On the Main Menu, use Left/Right arrow keys to move cursor box to Report menu icon.
- Press ✓ key to select the Report menu.
- Under Report Menu, select the HISTORY option and then press ✓ key to access it.
- The EVENT HISTORY will open, e.g.:

nnnn : PANEL RESET

nnnn : BATTERY MISSING

nnnn : MAINS FAIL

Note – Where nnnn represents an automatically assigned four-digit sequential number, allocated to each event.

- Use the Up/Down arrow keys to access relevant event and press ✓ key to display the date and time the selected event occurred:

nnnn : dd-MMM-yy hh:mm:ss

Note – where:

nnnn = sequential number allocated to the event

dd = day

MMM = Month

yy = Year

hh = hour

mm = minutes

ss = seconds

- Next, press return  key or ✓ key to return to the Report Menu.

Report Menu: COUNTER

To get ALARM COUNT information:

- On the Main Menu, use Left/Right arrow keys to move cursor box to Report menu.
- Press ✓ key to select the Report menu.
- Under Report Menu select the COUNTER option and then press ✓ key to access it.



- The ALARM COUNT sub-menu will open, and the following information will be available:

ALARM COUNT: nnnn – number (n) of alarm events that have occurred

LAST ALARM AT: dd-MMM-yy hh:mm:ss (date and time when the last event happened)

HOLD DOWN SELECT TO RESET: press and hold down ✓ key and the following will be displayed:

Enter Level 4 Access Code

- Use the keypad to enter code 4444:
 - Press ✓ key
 - Use the Up/Down arrow keys to increase/decrease the number value of the first digit in the 4-digit sequence.
 - Use the Left/Right arrow keys to move to the next digit in the 4-digit sequence
 - When all 4 digits have been set to the code 4444 press ✓ key once again.
- This action will clear to zero the value of any Alarm Count (if more than zero). A short acknowledgement sound will be present.
- Press return  key to return to Report Menu.
- Press return  key again to return to the Main Menu.

Report Menu: Versions

To access the software Versions information:

- On the Main Menu, use Left/Right arrow keys to move cursor box to Report menu.
- Press ✓ key to select the Report menu.
- Under Report Menu, select the Versions option and then press ✓ key to access it.
- Versions information will be displayed, as follows:

Versions

DISPLAY: VER: n.n_nnnn

SITE DATA: dd-MMM-yy hh:mm:ss nnnn

PSU: VER: n.nn

AREA 1: VER: n.n.nn

AREA 2: VER: n.n.nn

AREA 3: VER: n.n.nn

AREA 4: VER: n.n.nn

Note – Where:

n = displayed number

dd = day

MMM = Month

yy = year

Note: The number of AREA versions displayed depends on the AOV Cards fitted.

- Next, press return  key or ✓ key to return to the Report Menu.

Report Menu

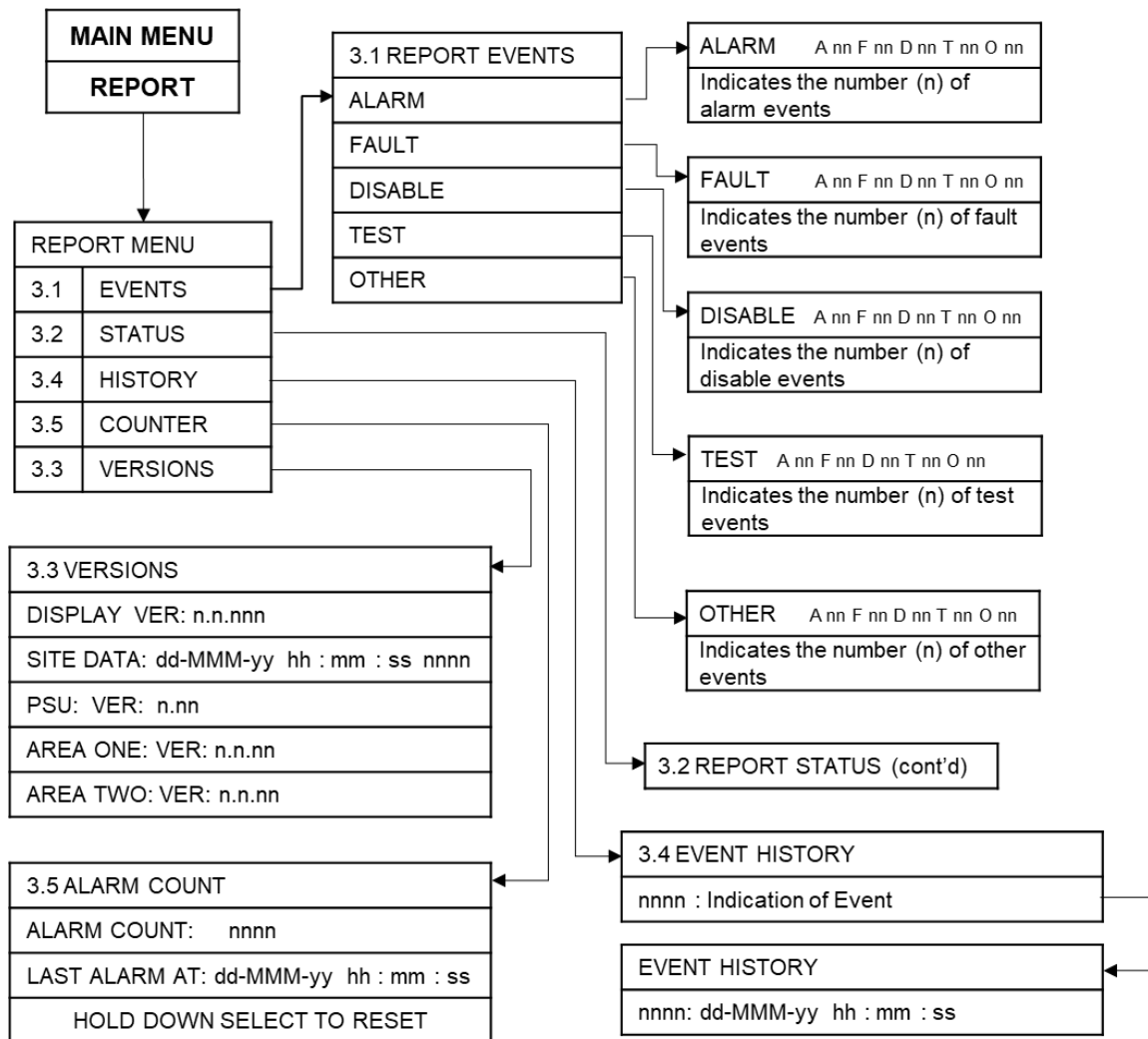

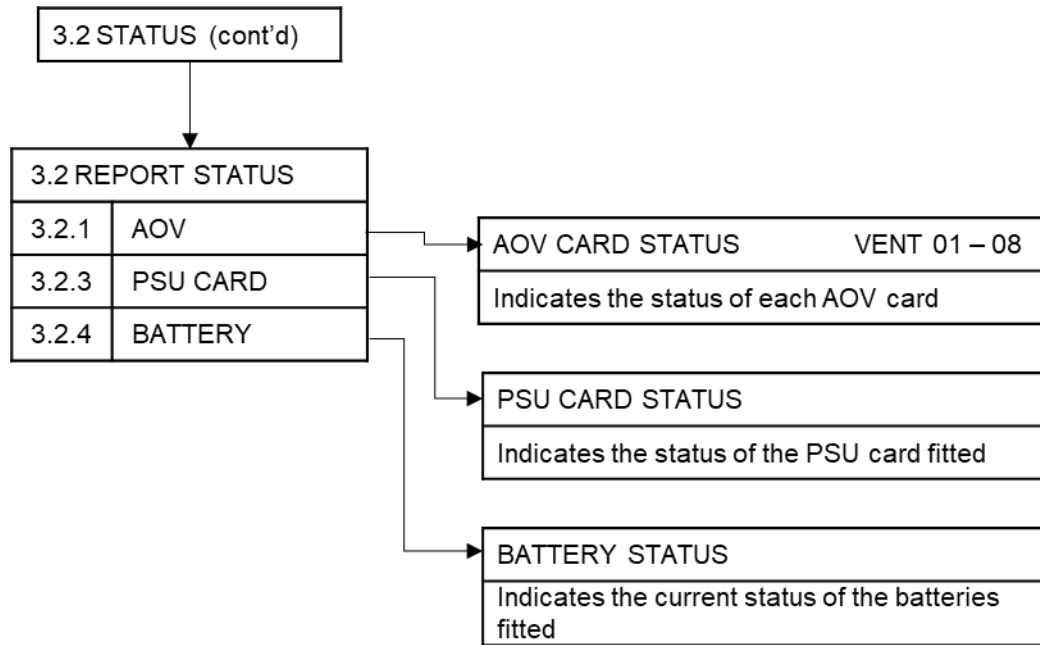

ENG Menu

From the ENG menu on the Main Menu, the following sub-menus are available:

- OUTPUTS

ENG Menu: OUTPUTS

To set the test output for the external devices connected to the system, access the ENG menu OUTPUTS sub-menu:

- Turn Activate Controls Key to On, or use the keypad to enter code 1111:
 - Press ✓ key
 - Use the Up/Down arrow keys to increase/decrease the number value
 - Use the Left/Right arrow keys to move to the next digit in the 4-digit sequence
 - When all 4 digits have been set to the code 1111 press ✓ key once again. The Main Menu will become available for operation
- On the Main Menu, use Left/Right arrow keys to move cursor box to highlight ENG menu.
- Press ✓ key to select the ENG menu.
- Under ENG Menu, highlight the OUTPUTS option, and then press ✓ key to select it.
- Under the Tech OUTPUTS menu, the following information will be available:

Tech OUTPUTS

1: VENT ONE: CLOSED/10% - 90%/OPEN

2: VENT TWO: CLOSED/10% - 90%/OPEN

to



8: VENT EIGHT: CLOSED/10% - 90%/OPEN

9: 1st RSU: CLOSED/10% - 90%/OPEN

to

40: 32nd RSU: CLOSED/10% - 90%/OPEN

Note: Unfound vents and RSUs will appear 'struck-through', as shown.

- Press return  key once to return to ENG menu.
- Press return  key again to return to Main Menu.

ENG Menu

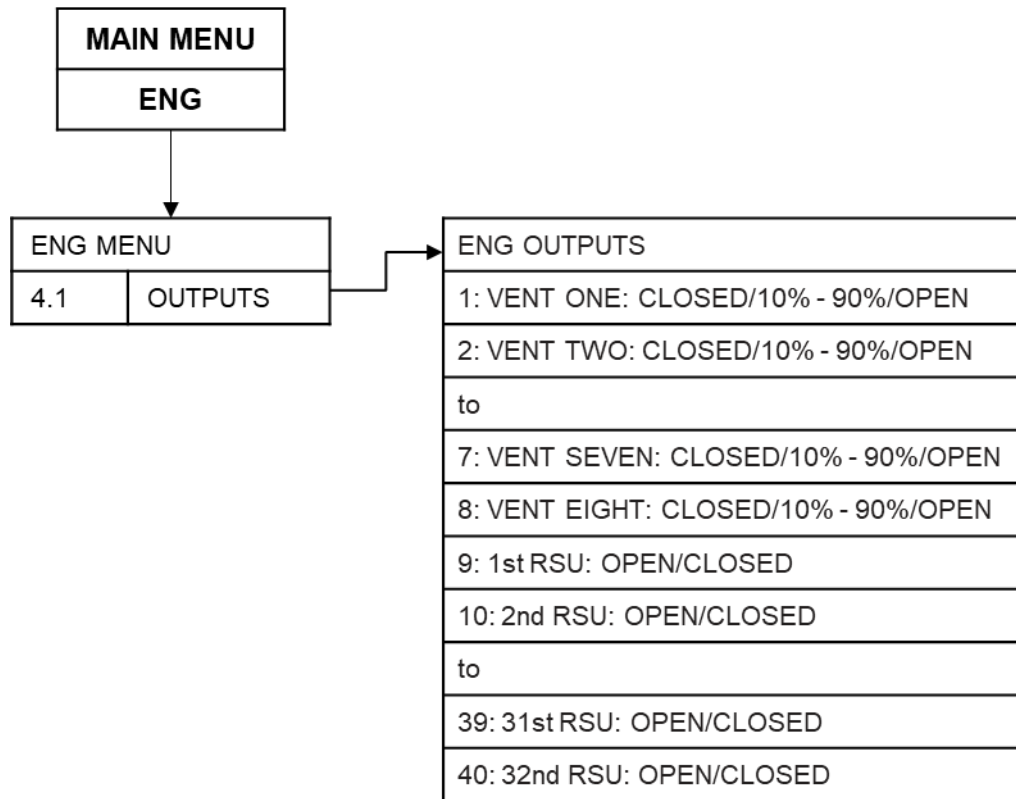

Summary of Menu Structure

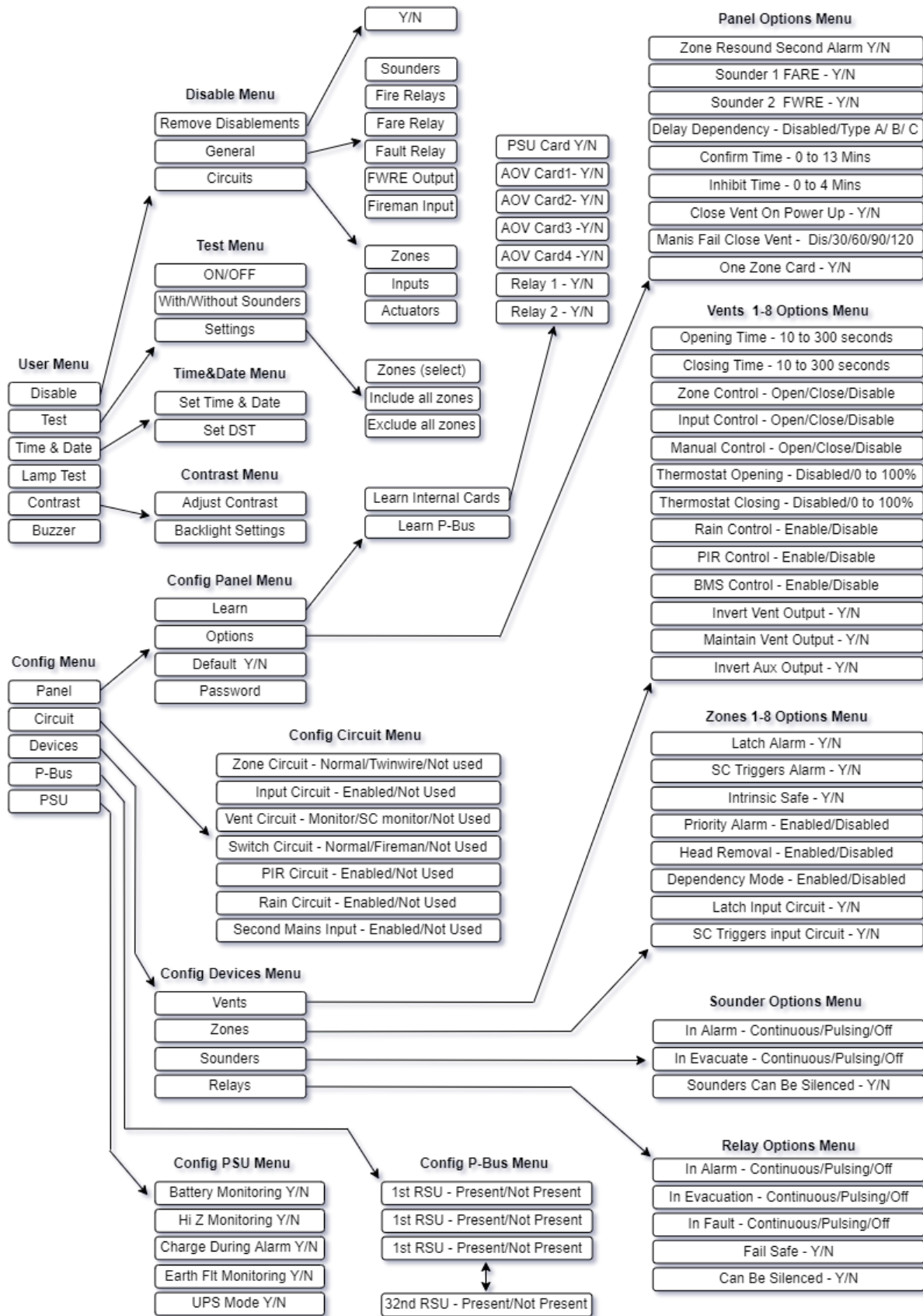

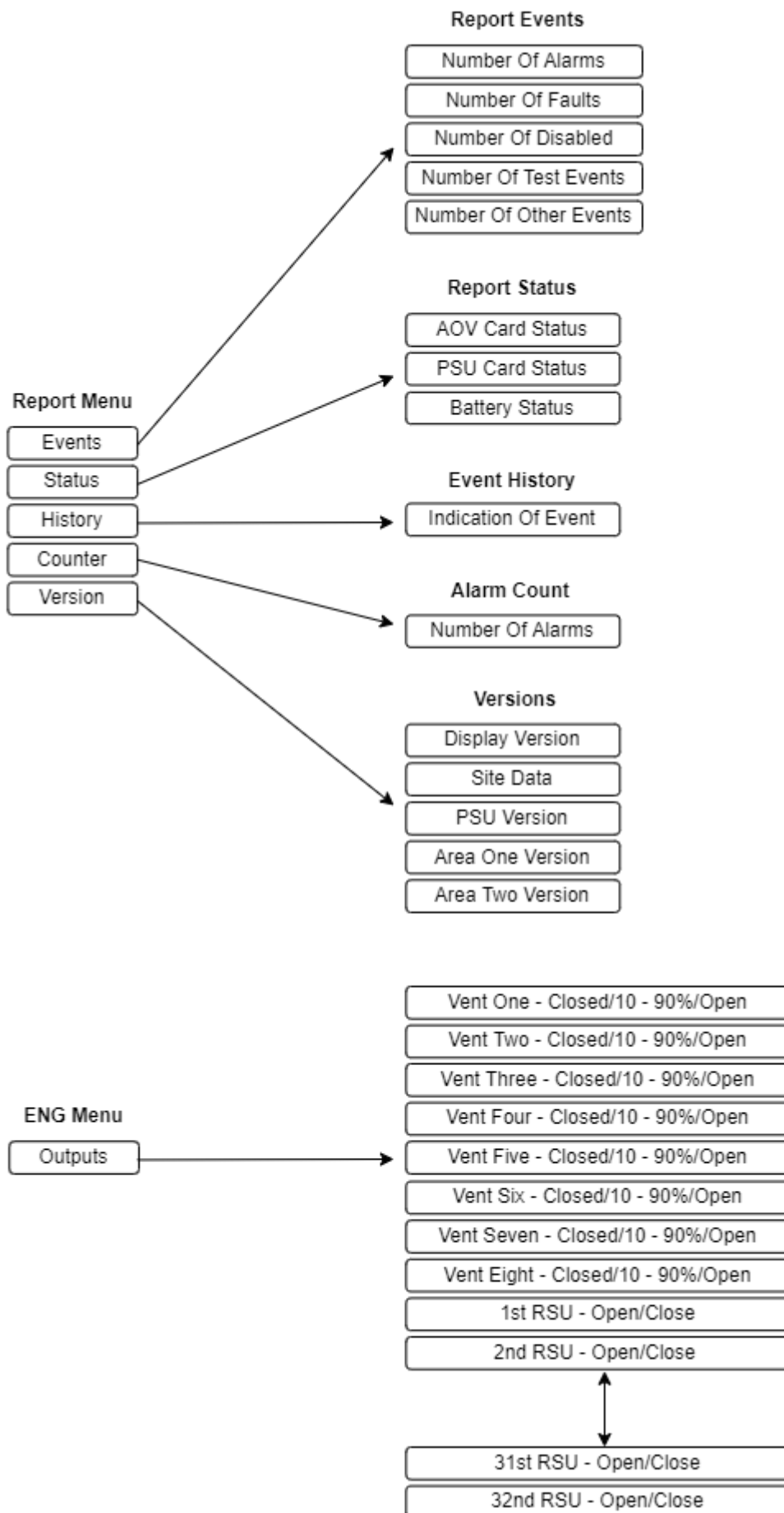

SERVICE & MAINTENANCE

The product must be maintained for operation, including periodic checks, in accordance with applicable codes of practice, national standard regulations and local instructions for fire systems appropriate to the country and location of the installation. It is the responsibility of the system user to ensure it is regularly serviced and maintained in good working order.

